

# 風配図 - 月別

測定局：国設大阪

2011年4月～2012年3月 1～24 時

風向風速計高さ 32.8 m

--- 出現頻度

— 平均風速

円内 無風%  
測定時間数

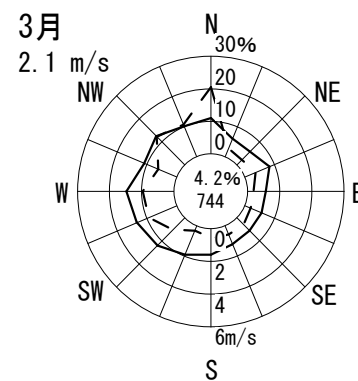
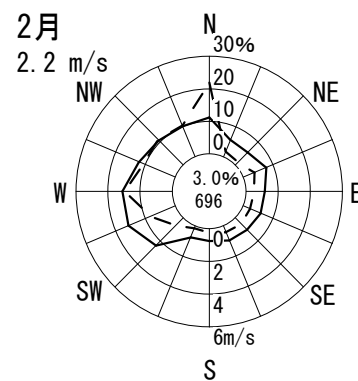
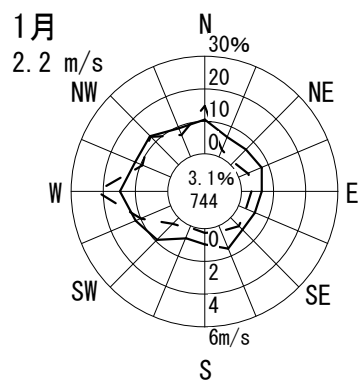
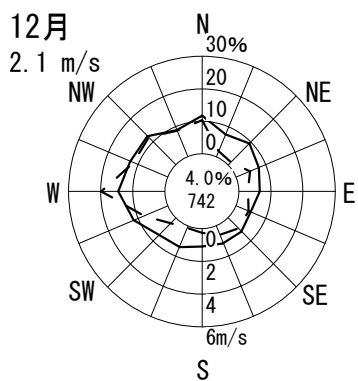
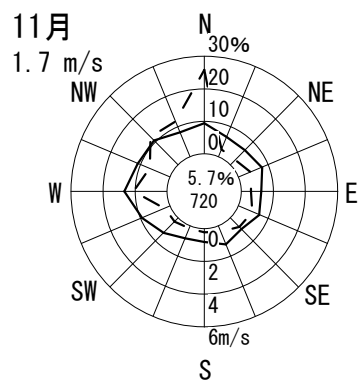
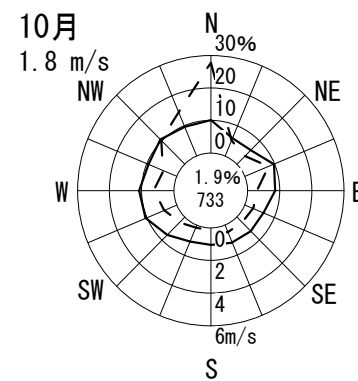
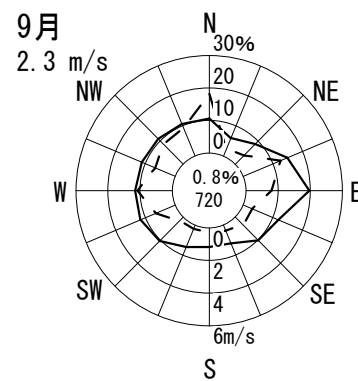
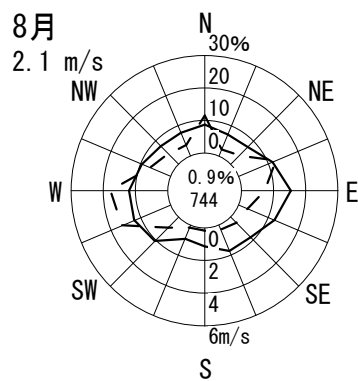
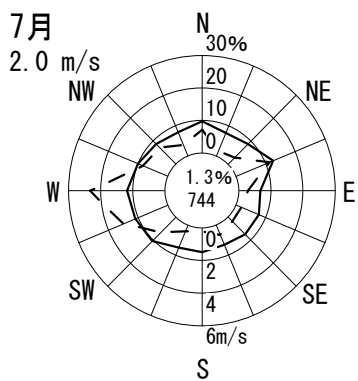
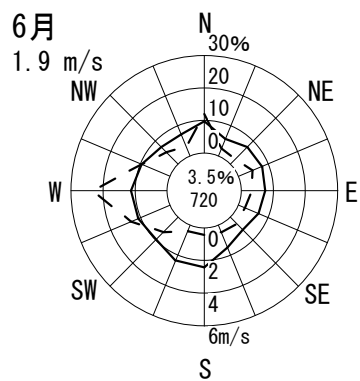
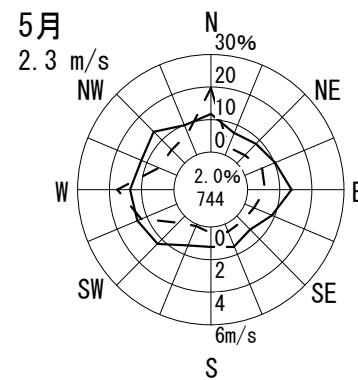
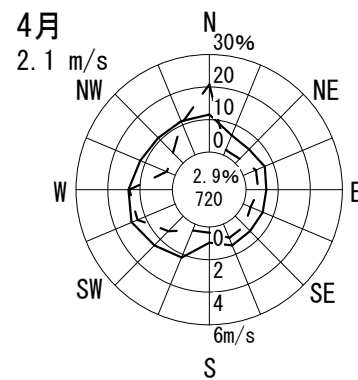
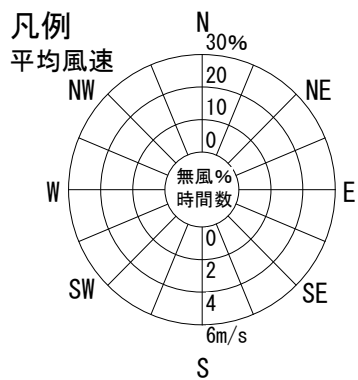
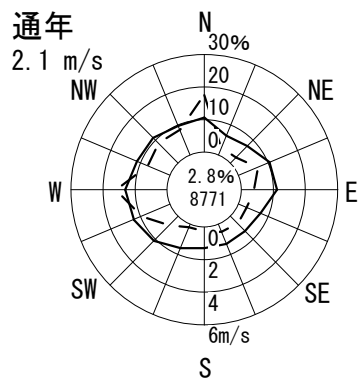

# 風配図 - 月別

測定局：此花区役所

2011年4月～2012年3月 1～24 時

風向風速計高さ 17.0 m

--- 出現頻度  
—— 平均風速

円内 無風%  
測定時間数

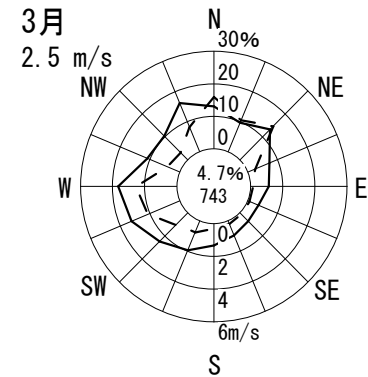
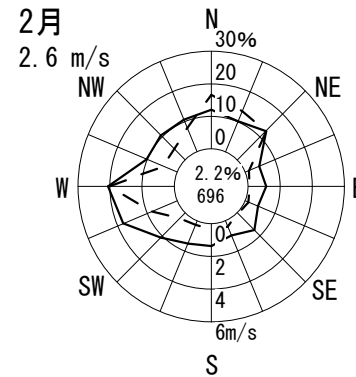
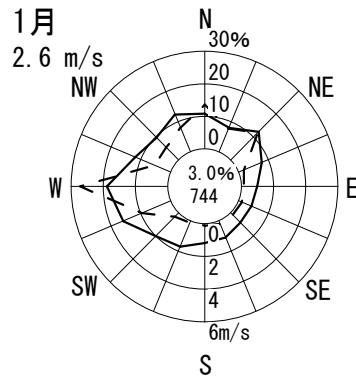
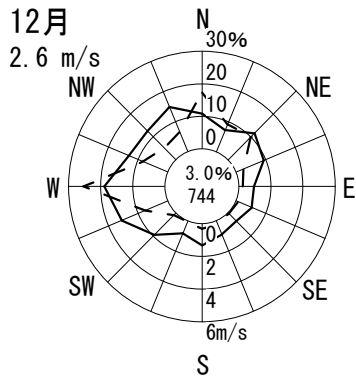
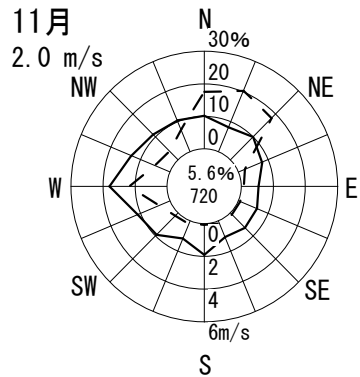
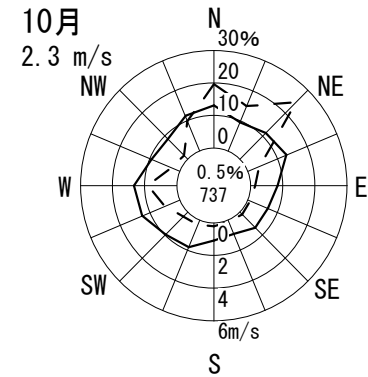
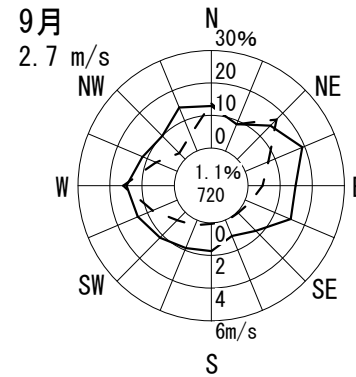
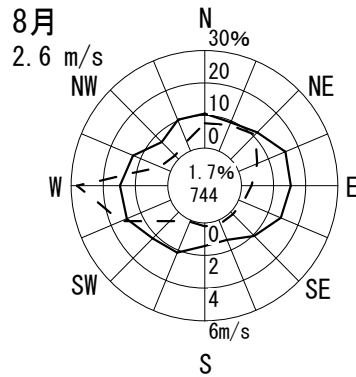
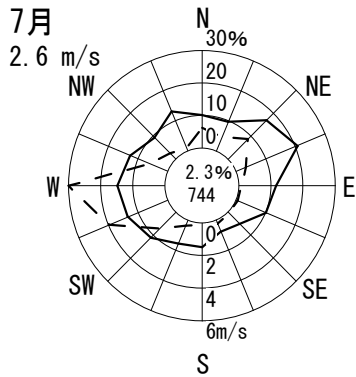
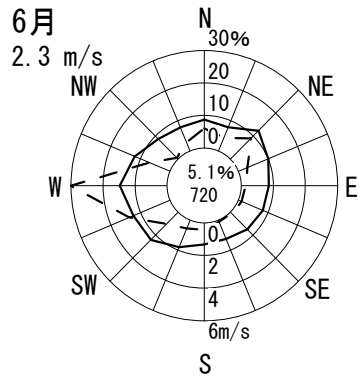
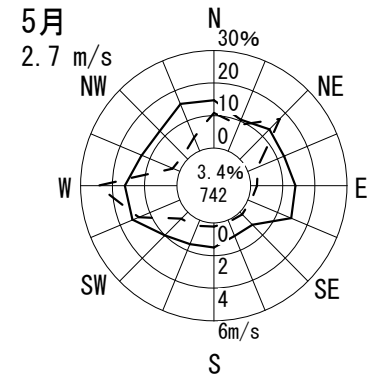
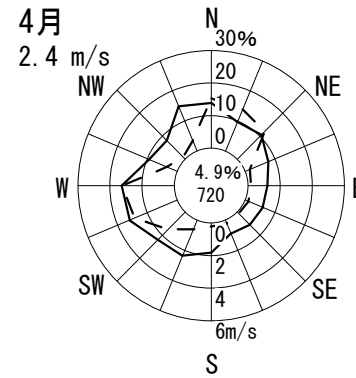
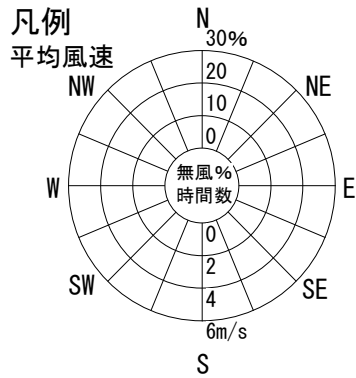
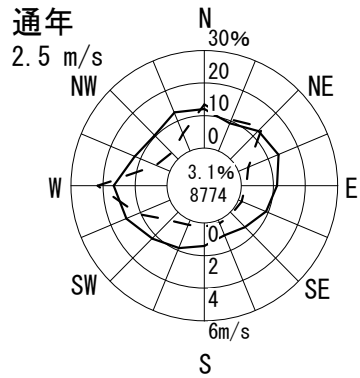

# 風配図 - 月別

測定局：平尾小学校

2011年4月～2012年3月 1～24 時

風向風速計高さ 18.0 m

--- 出現頻度

— 平均風速

○ 無風%  
● 測定時間数

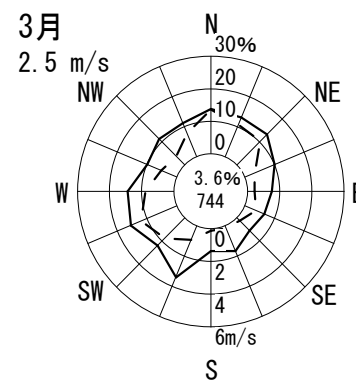
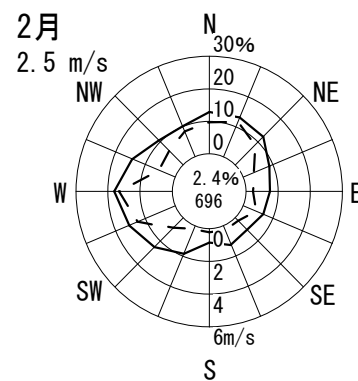
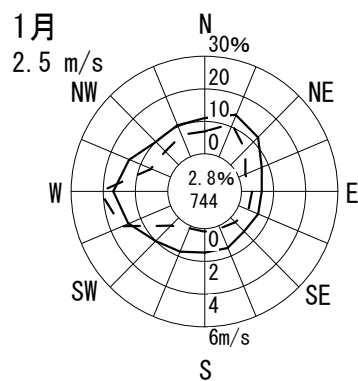
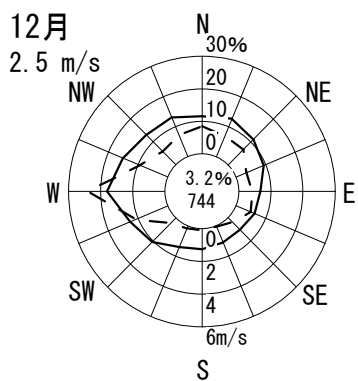
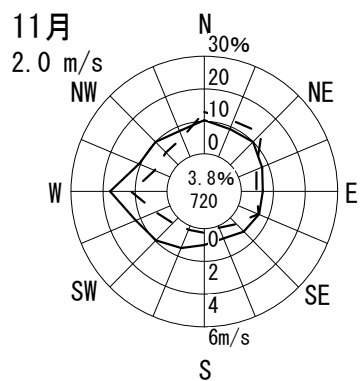
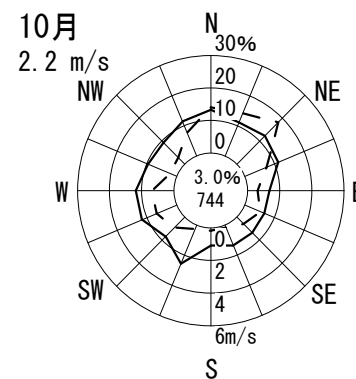
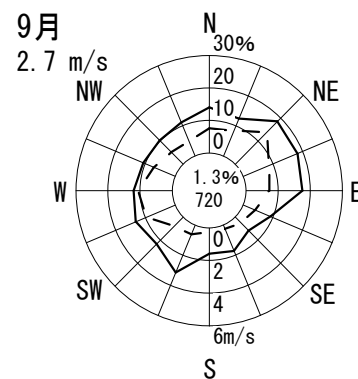
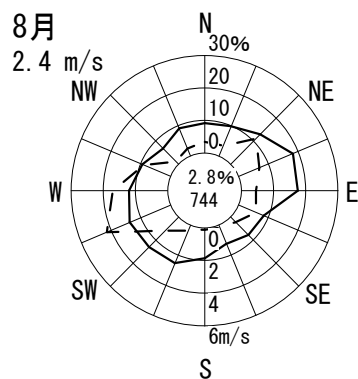
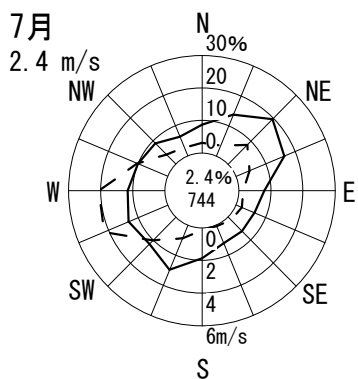
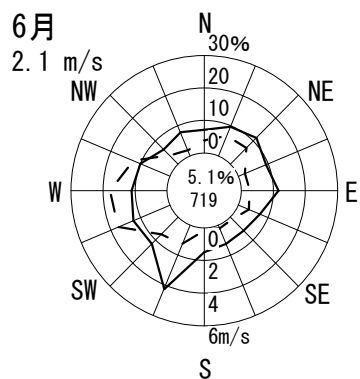
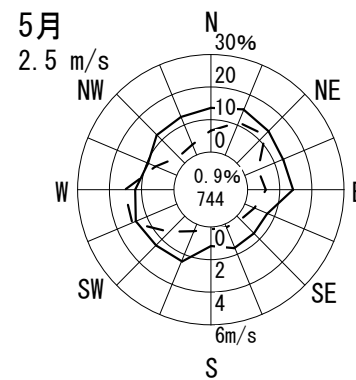
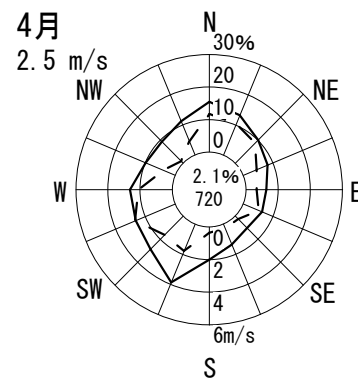
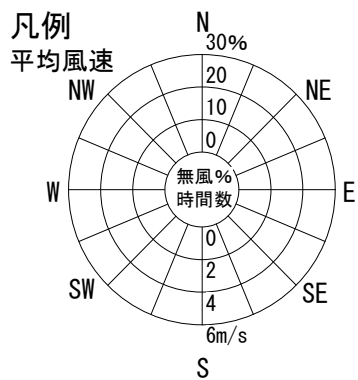
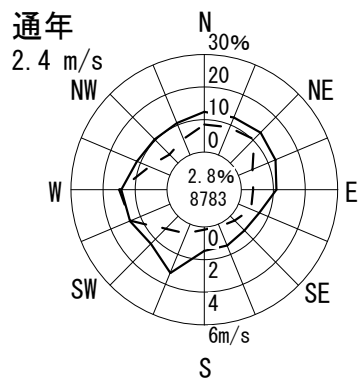

# 風配図 - 月別

測定局：淀中学校

2011年4月～2012年3月 1～24 時

風向風速計高さ 20.0 m

--- 出現頻度

— 平均風速

円内 無風%  
測定時間数

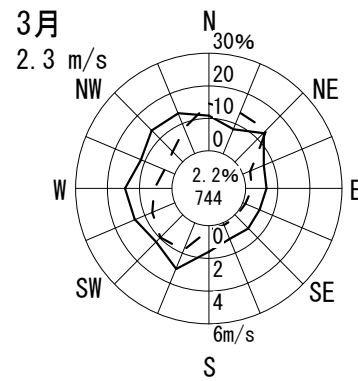
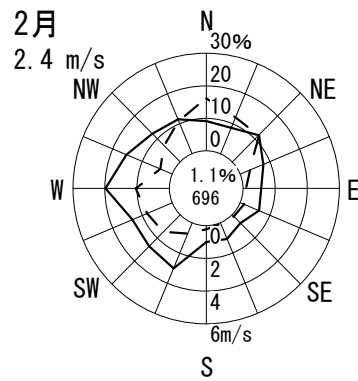
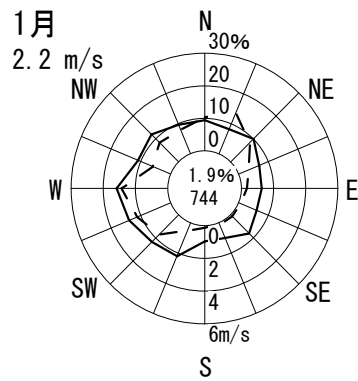
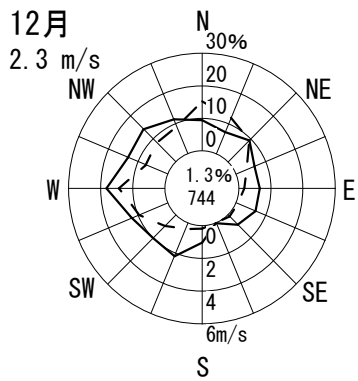
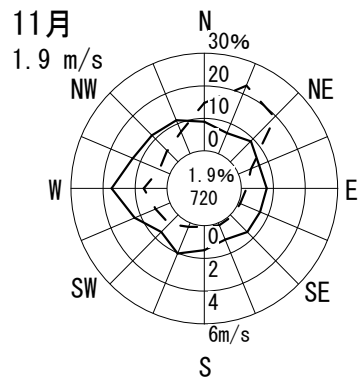
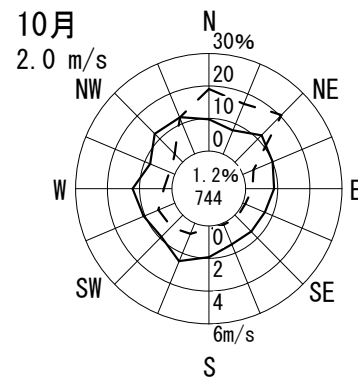
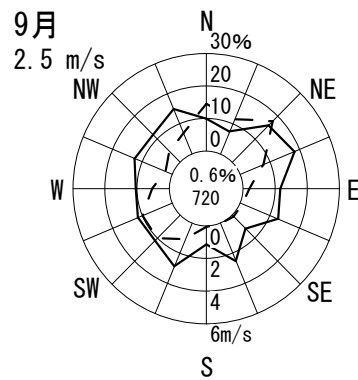
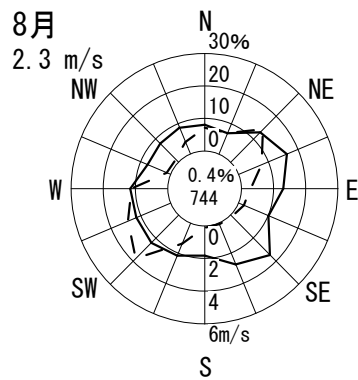
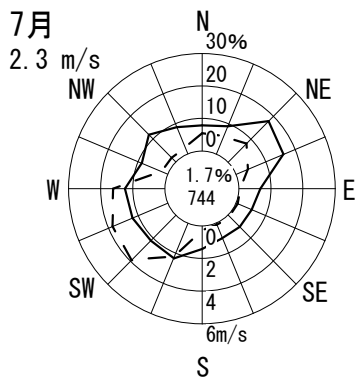
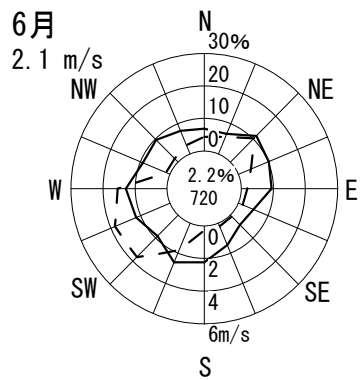
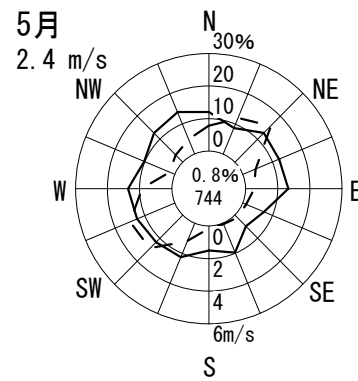
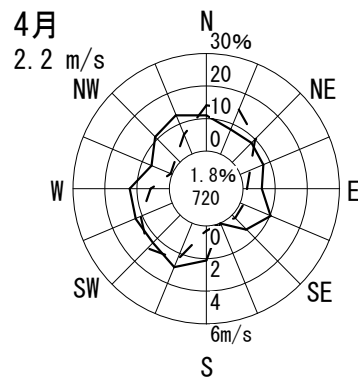
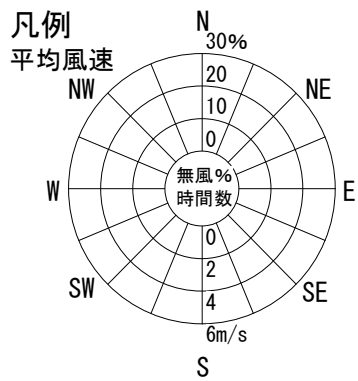
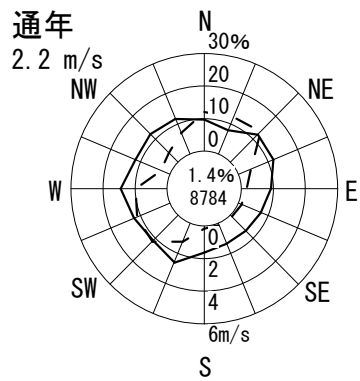

# 風配図 - 月別

測定局：旧淀川区役所

2011年4月～2012年3月 1～24 時

風向風速計高さ 20.0 m

--- 出現頻度

— 平均風速

○内 無風%  
測定時間数

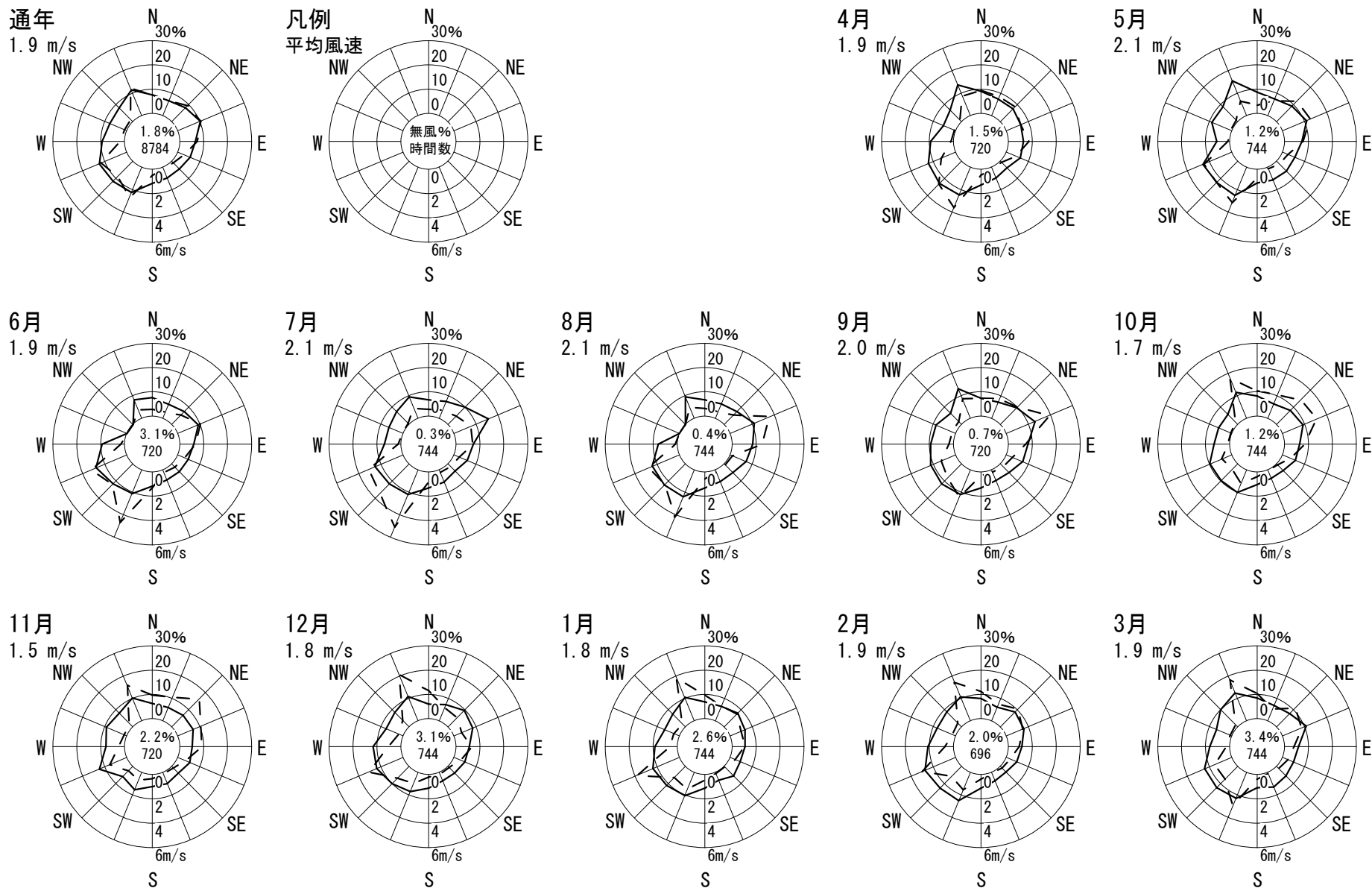

# 風配図 - 月別

測定局：勝山中学校

2011年4月～2012年3月 1～24 時

風向風速計高さ 21.0 m

--- 出現頻度

— 平均風速

円内 無風%  
測定時間数

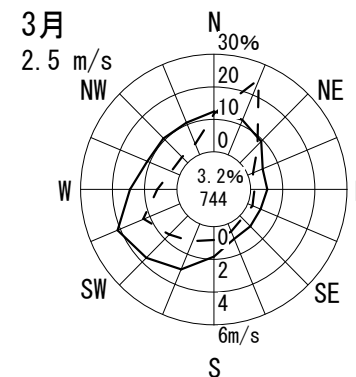
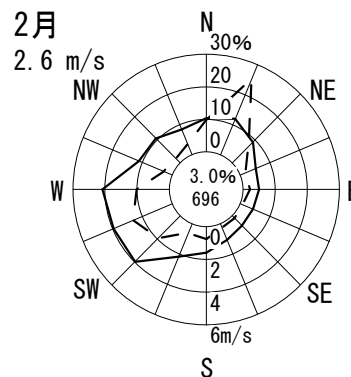
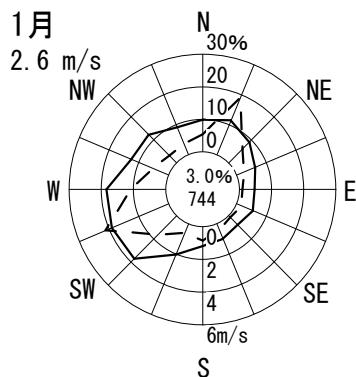
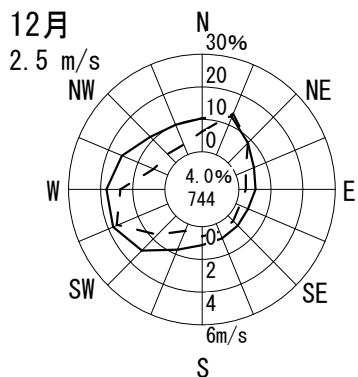
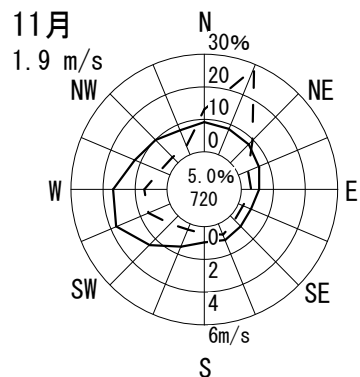
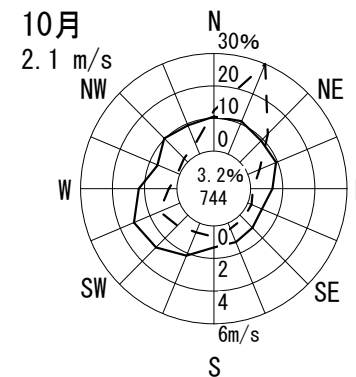
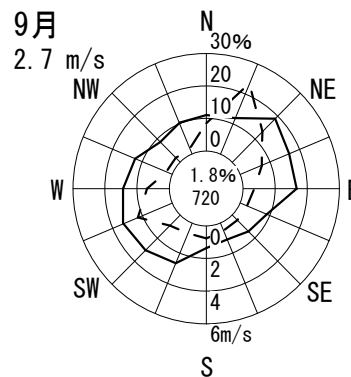
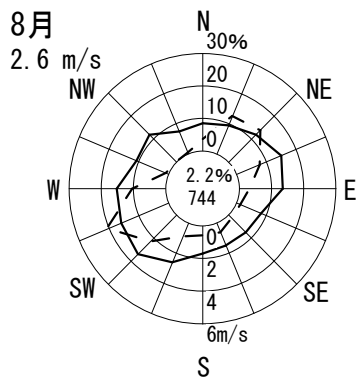
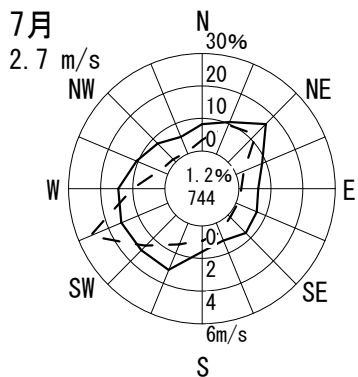
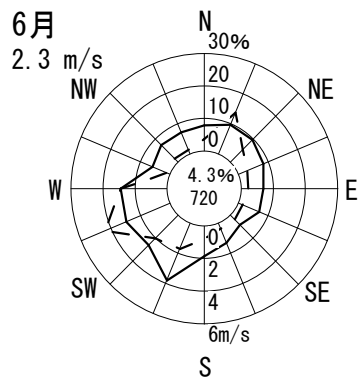
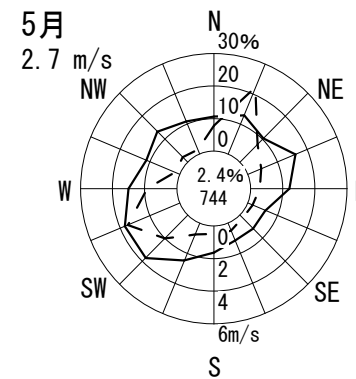
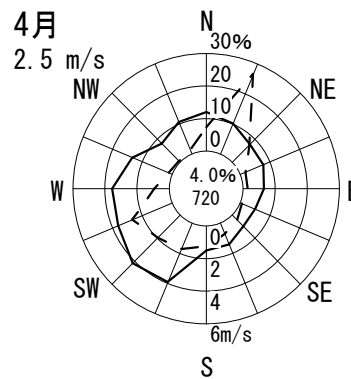
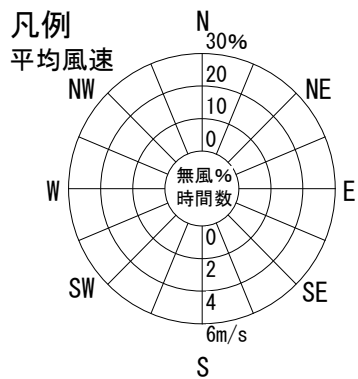
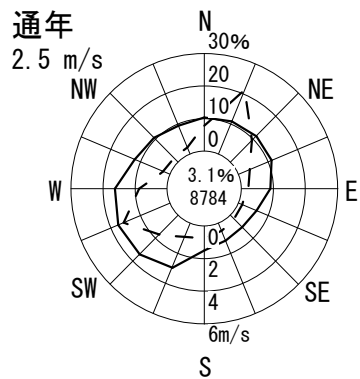

# 風配図 - 月別

測定局：大宮中学校

2011年4月～2012年3月 1～24 時

風向風速計高さ 17.0 m

--- 出現頻度

— 平均風速

円内 無風%  
測定時間数

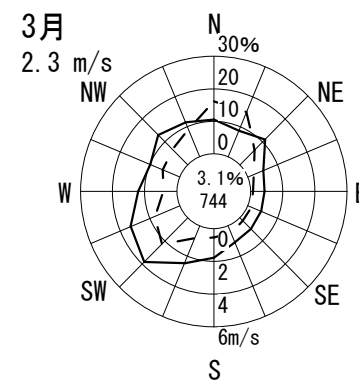
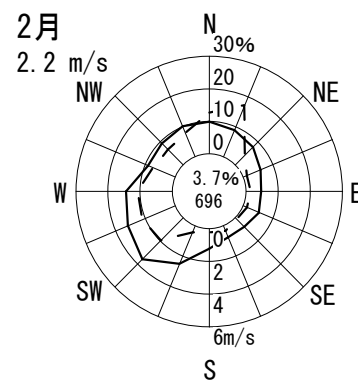
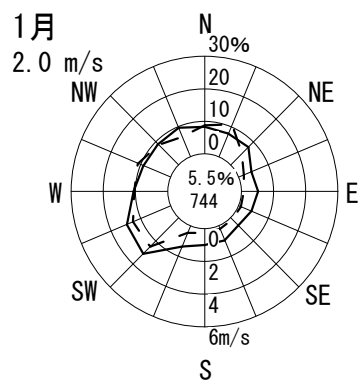
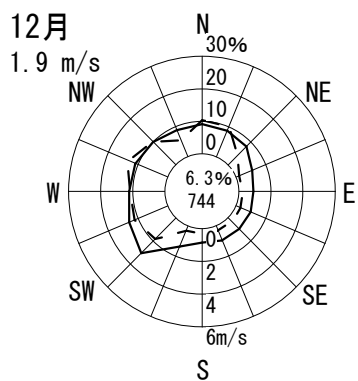
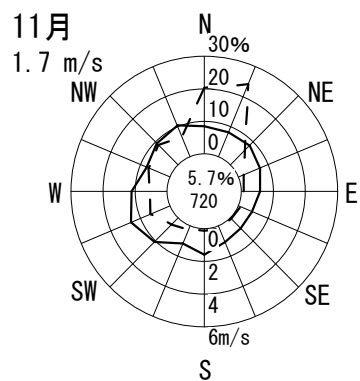
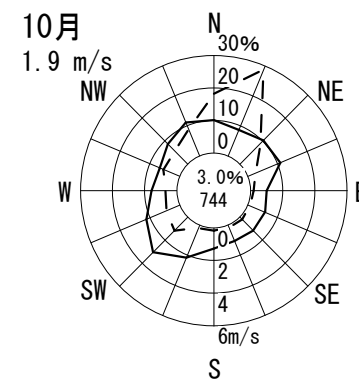
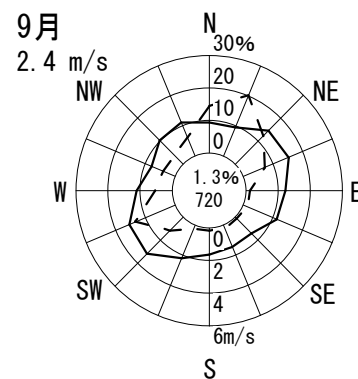
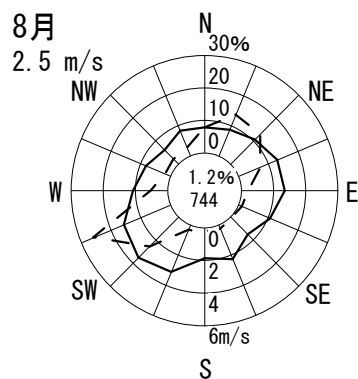
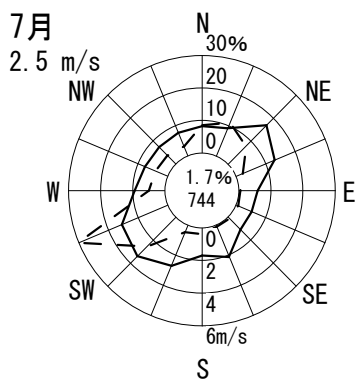
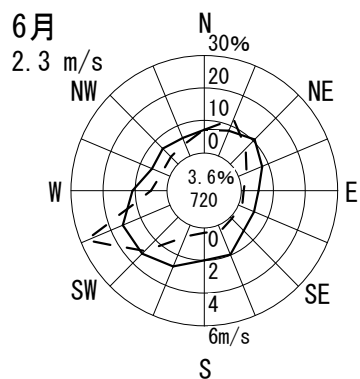
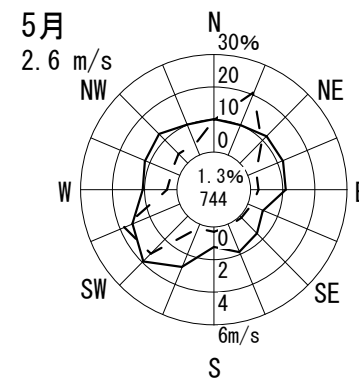
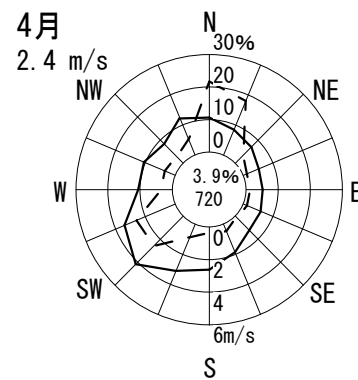
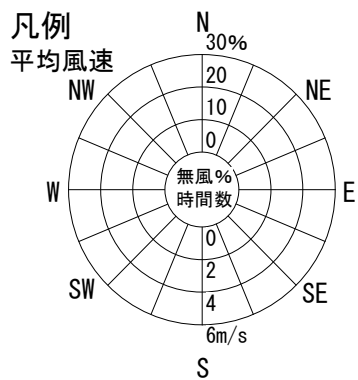
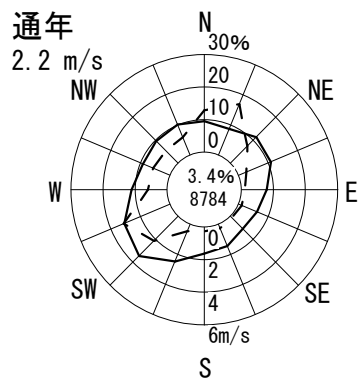

# 風配図 - 月別

測定局：聖賢小学校

2011年4月～2012年3月 1～24 時

風向風速計高さ 19.0 m

--- 出現頻度

— 平均風速

円内 無風%  
測定時間数

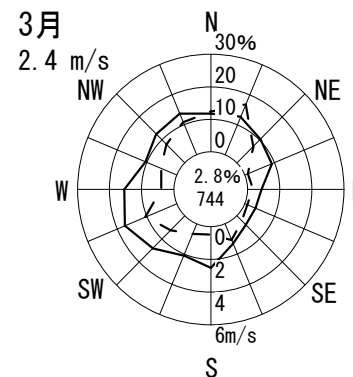
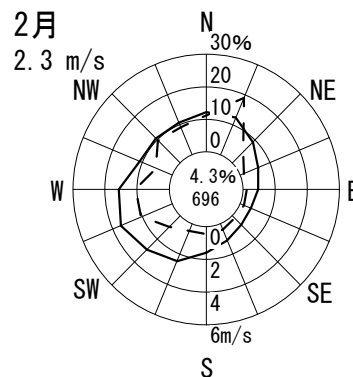
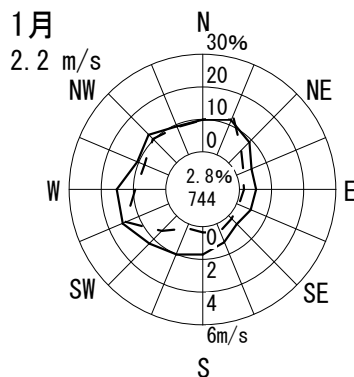
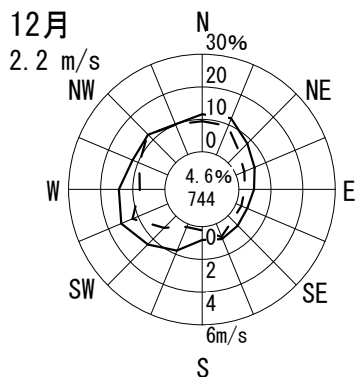
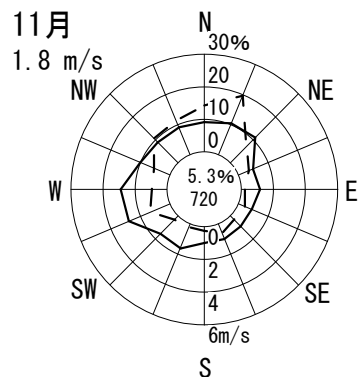
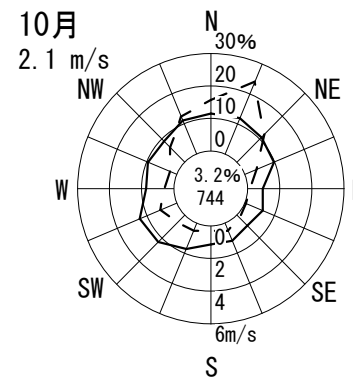
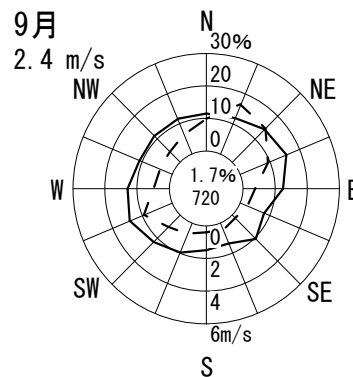
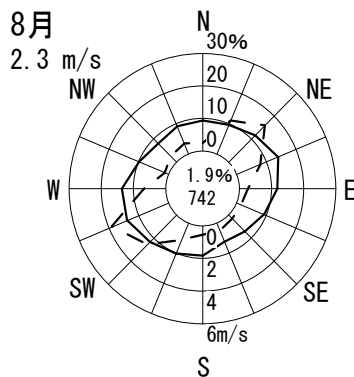
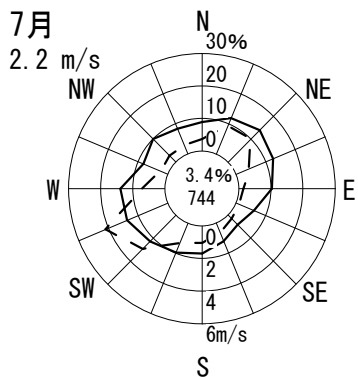
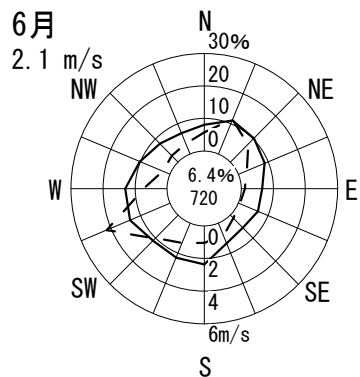
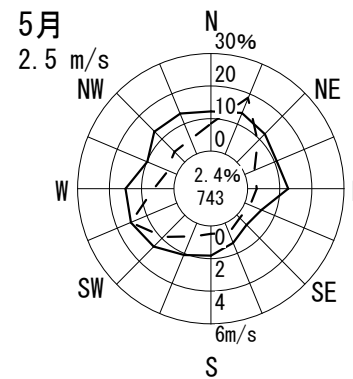
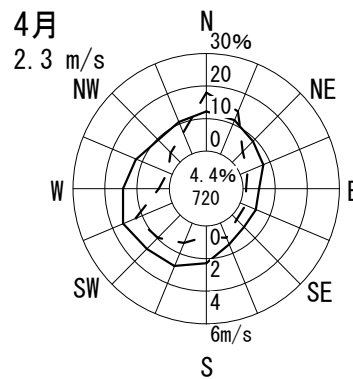
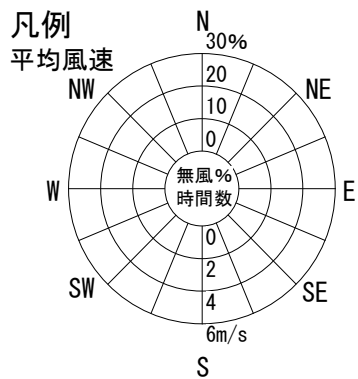
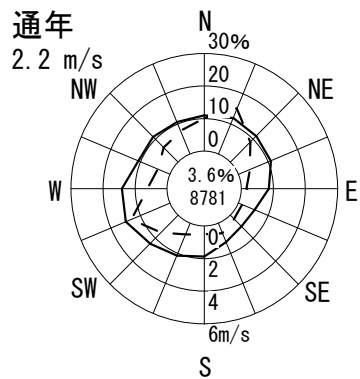



# 風配図 - 月別

測定局：清江小学校

2011年4月～2012年3月 1～24 時

風向風速計高さ 21.0 m

--- 出現頻度

— 平均風速

円内 無風%  
測定時間数

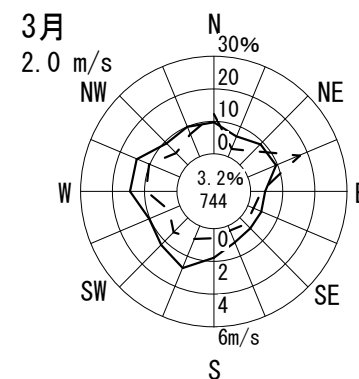
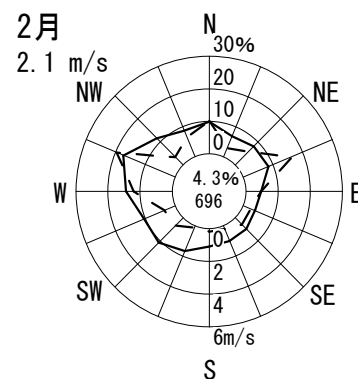
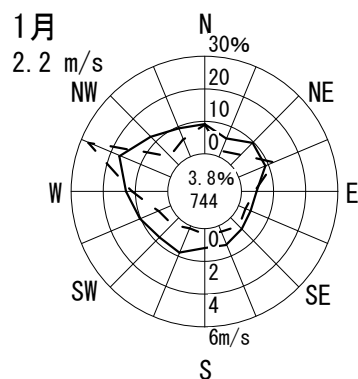
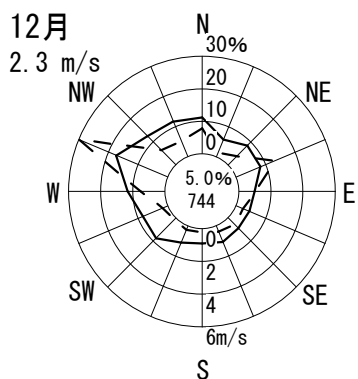
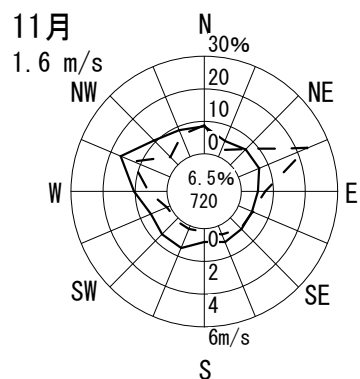
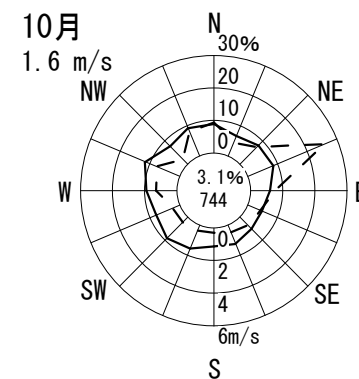
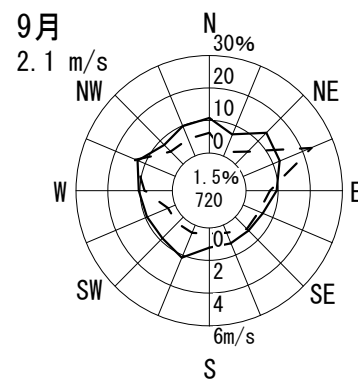
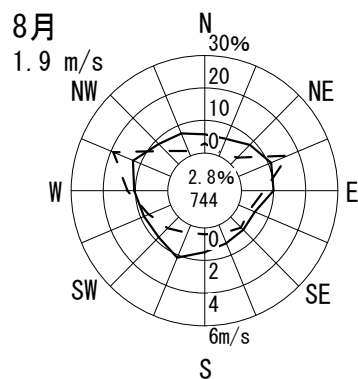
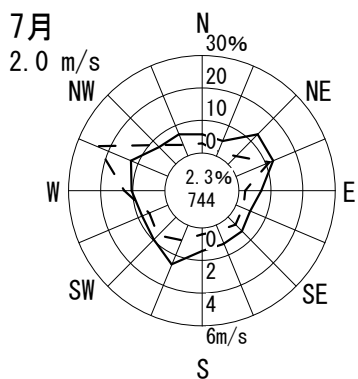
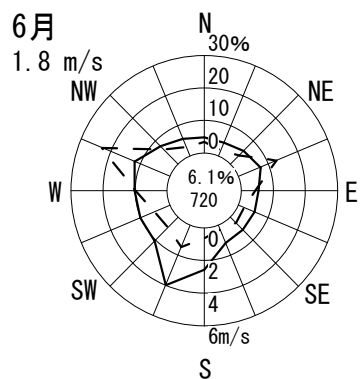
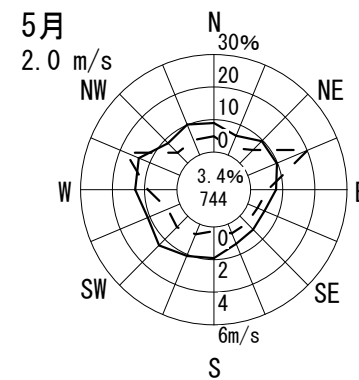
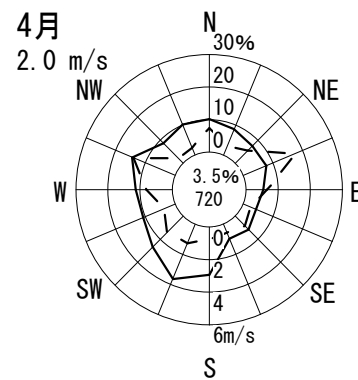
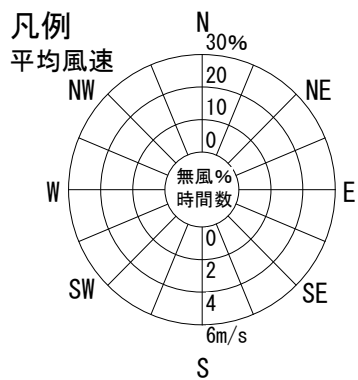
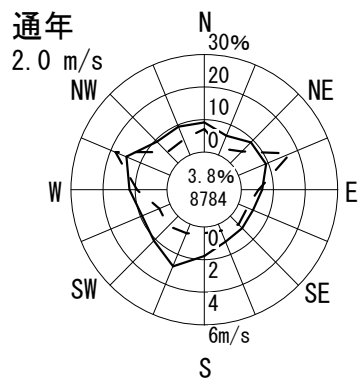

# 風配図 - 月別

測定局：摂陽中学校

2011年4月～2012年3月 1～24 時

風向風速計高さ 21.0 m

--- 出現頻度

— 平均風速

円内 無風%  
測定時間数

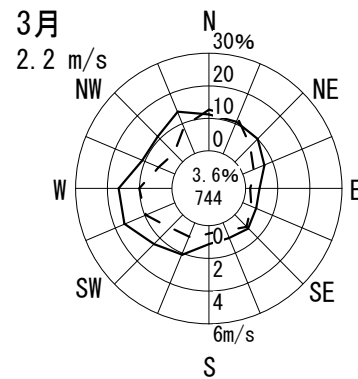
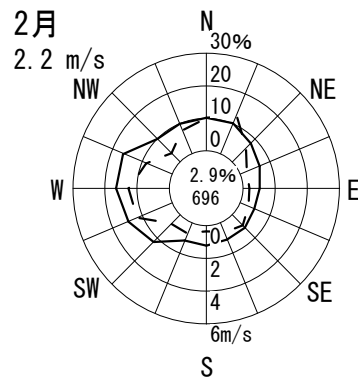
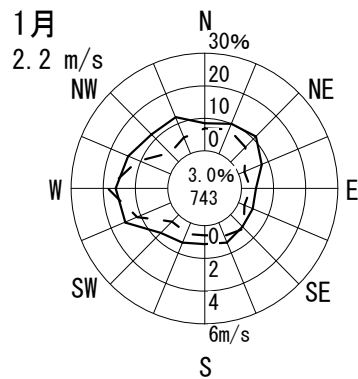
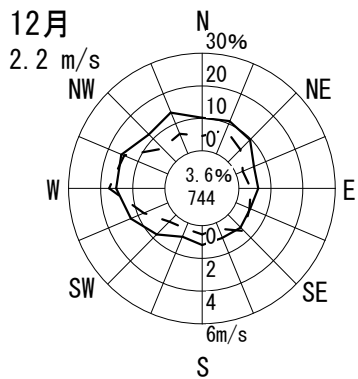
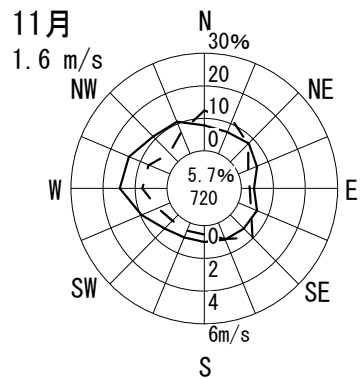
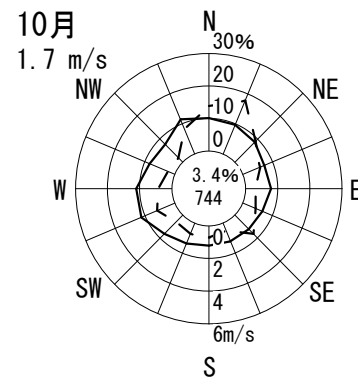
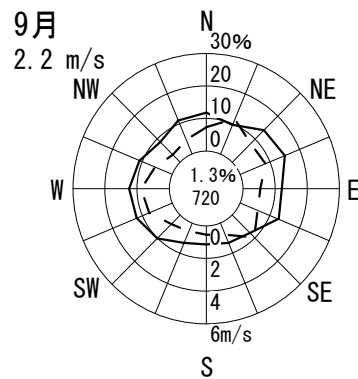
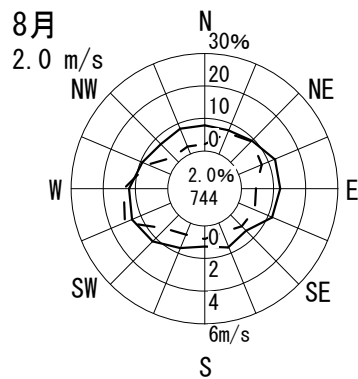
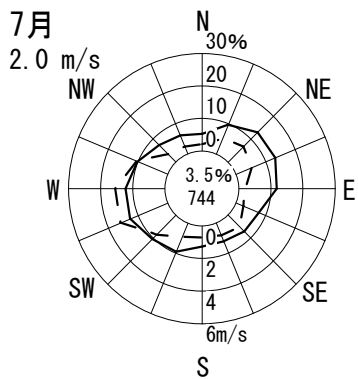
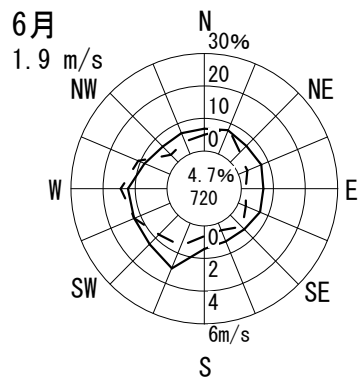
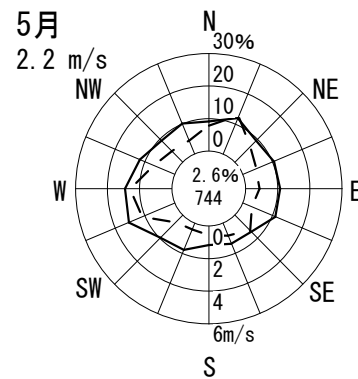
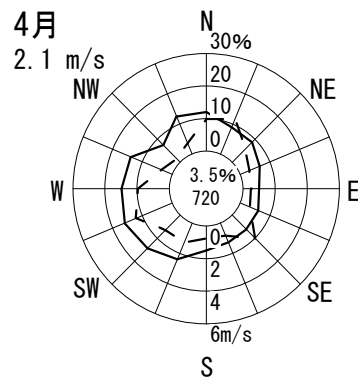
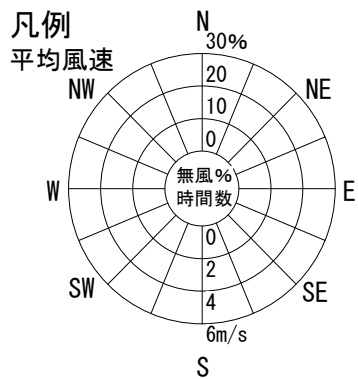
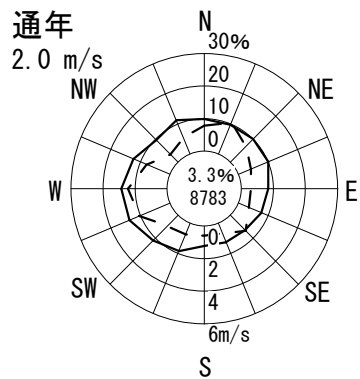

# 風配図 - 月別

測定局：今宮中学校

2011年4月～2012年3月 1～24 時

風向風速計高さ 16.0 m

--- 出現頻度

— 平均風速

円内 無風%  
測定時間数

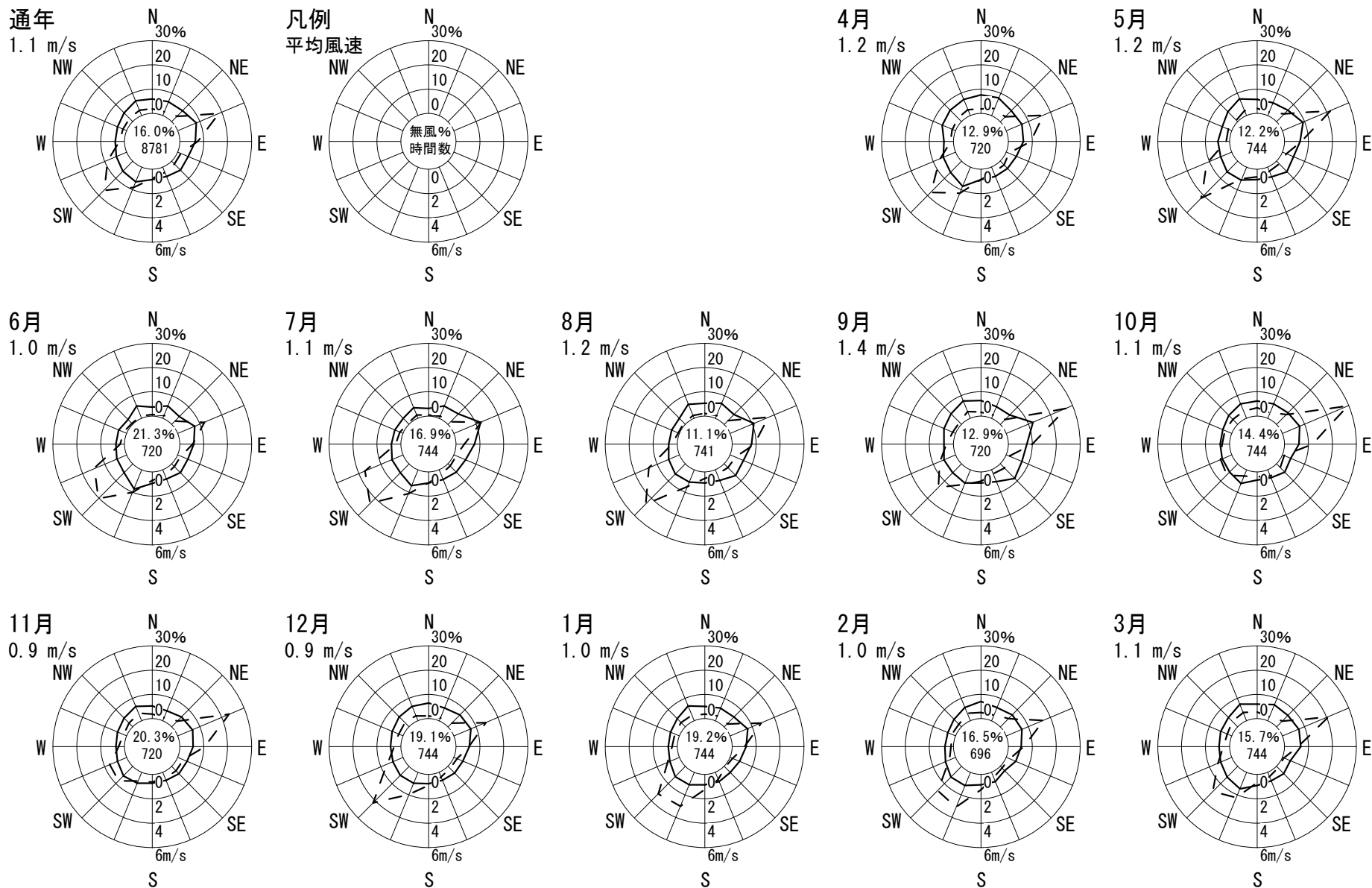

# 風配図 - 月別

測定局：南港中央公園

2011年4月～2012年3月 1～24 時

風向風速計高さ 14.0 m

--- 出現頻度

— 平均風速

○内 無風%

○内 測定時間数

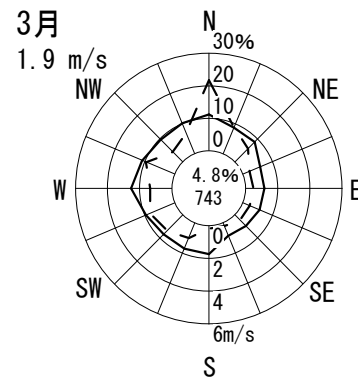
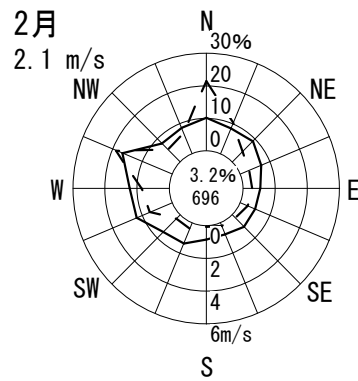
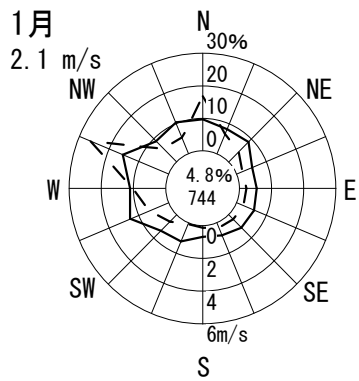
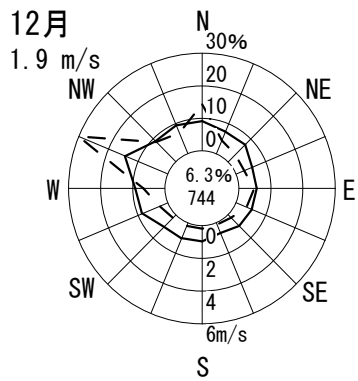
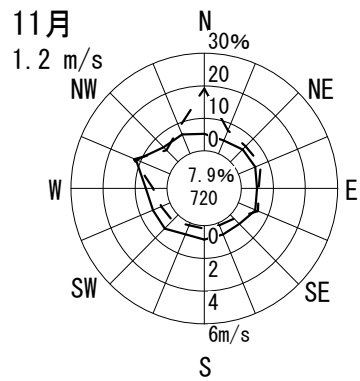
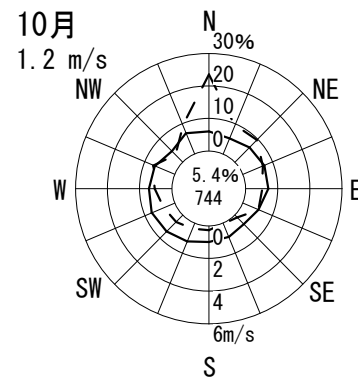
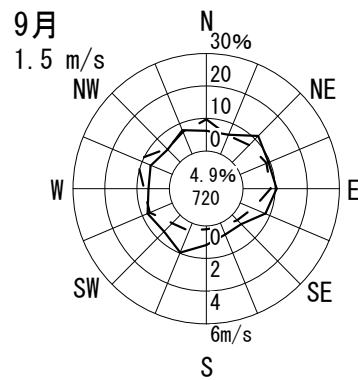
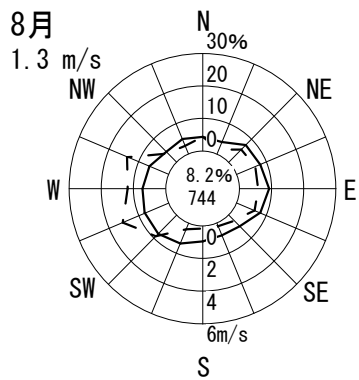
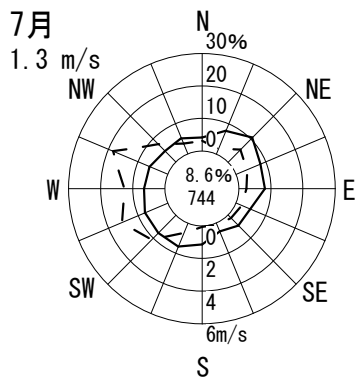
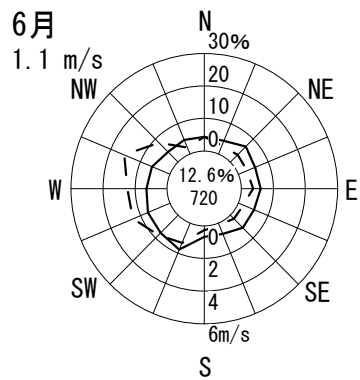
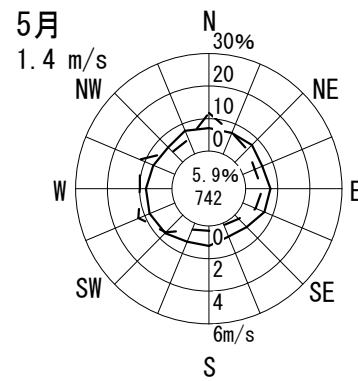
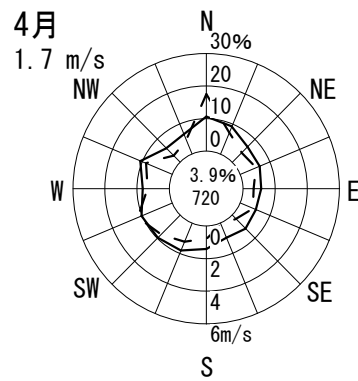
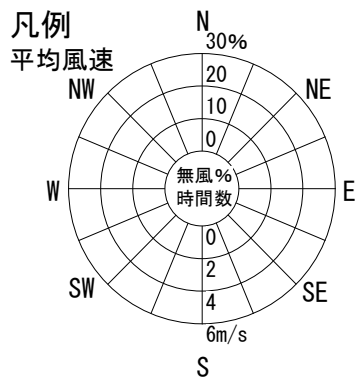
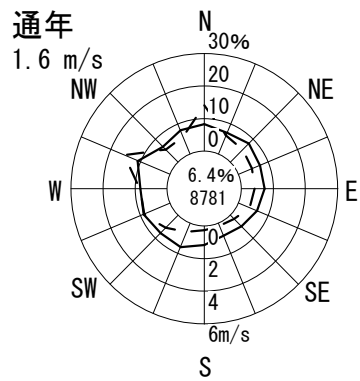

# 風配図 - 月別

測定局：少林寺

2011年4月～2012年3月 1～24 時  
風向風速計高さ 18.0 m

--- 出現頻度  
—— 平均風速

円内 無風%  
測定時間数

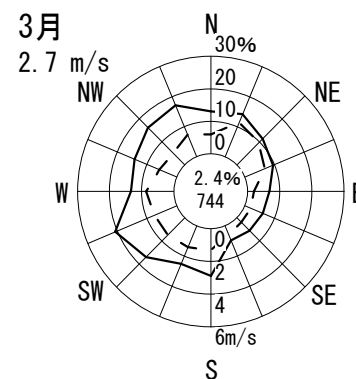
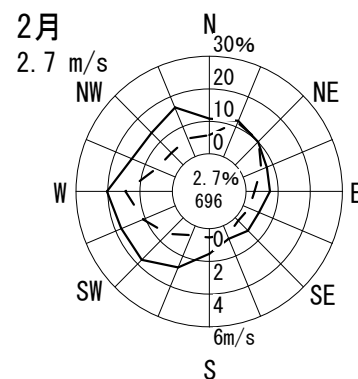
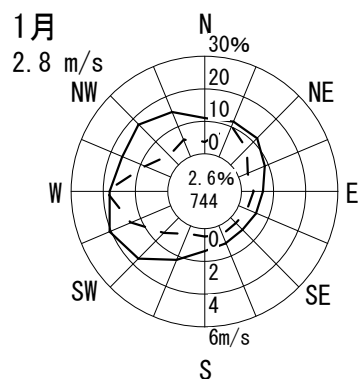
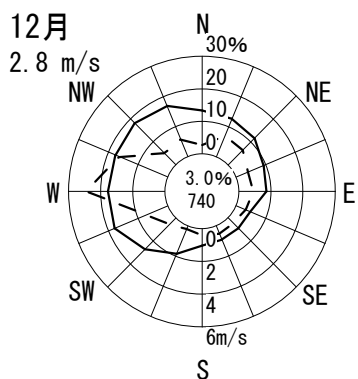
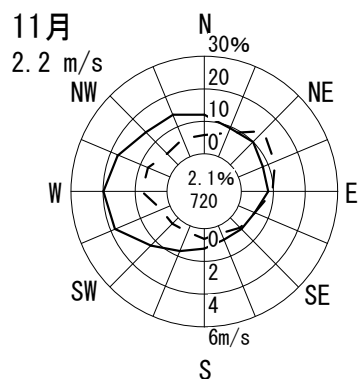
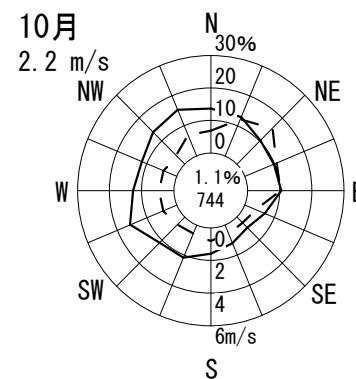
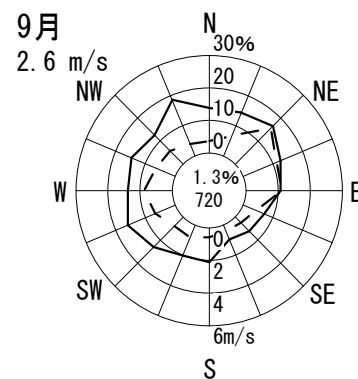
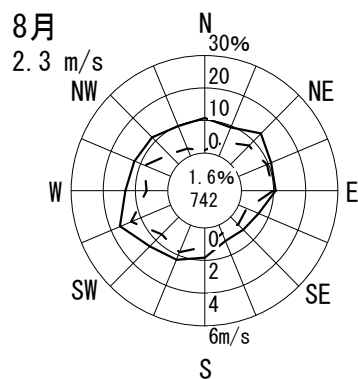
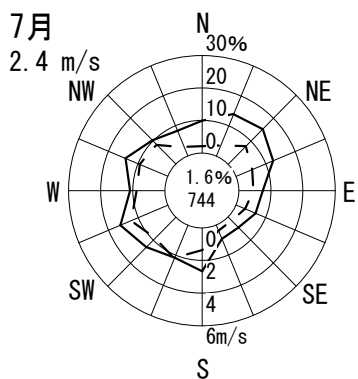
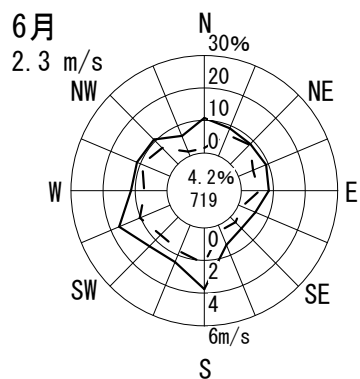
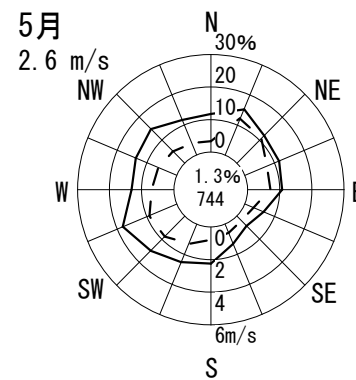
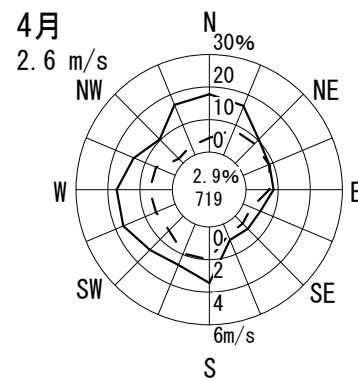
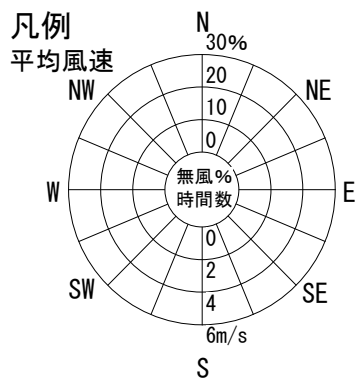
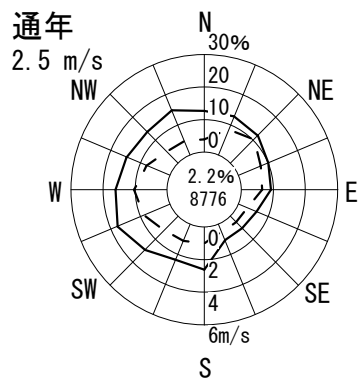

# 風配図 - 月別

測定局：浜寺

2011年4月～2012年3月 1～24 時

風向風速計高さ 18.0 m

--- 出現頻度

— 平均風速

円内 無風%  
測定時間数

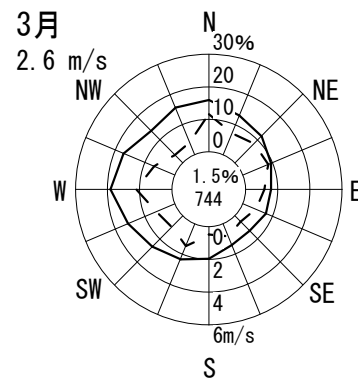
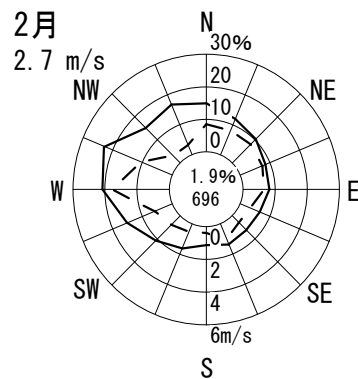
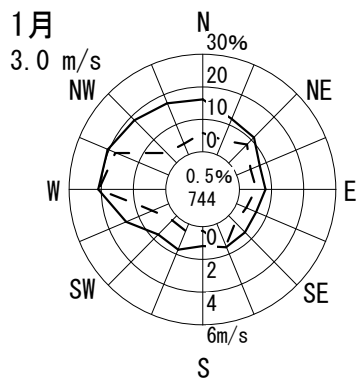
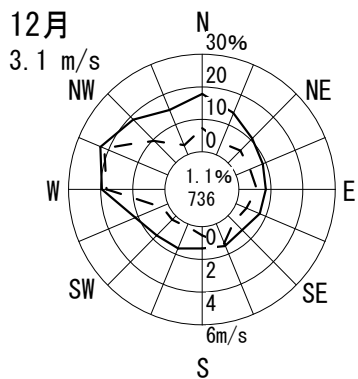
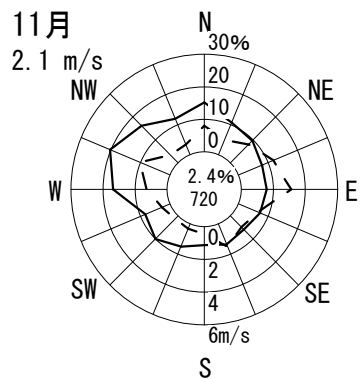
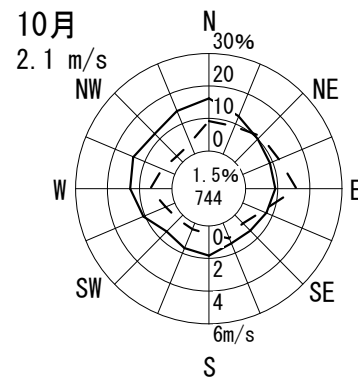
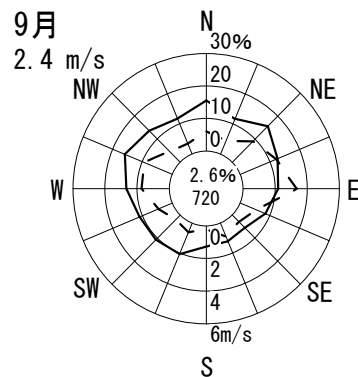
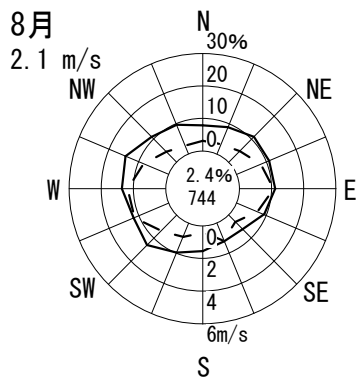
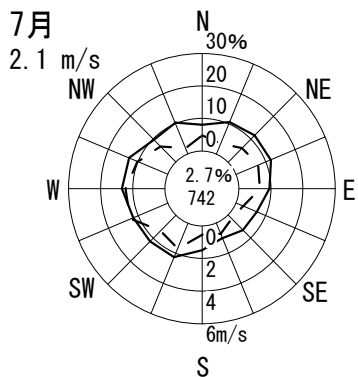
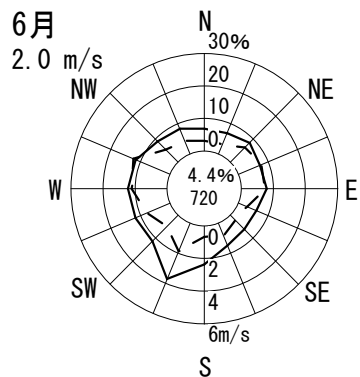
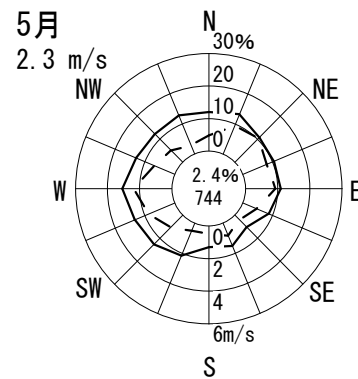
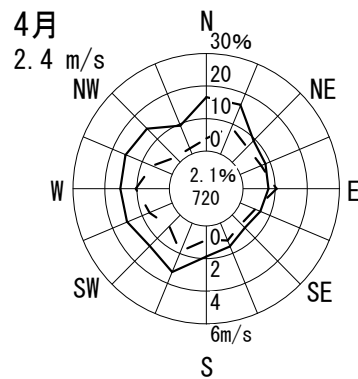
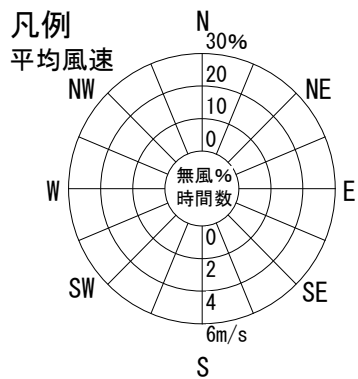
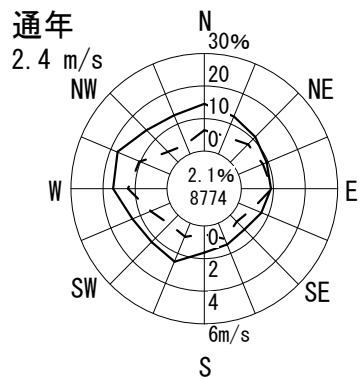

# 風配図 - 月別

測定局：石津

2011年4月～2012年3月 1～24 時  
風向風速計高さ 18.0 m

--- 出現頻度  
—— 平均風速

円内 無風%  
測定時間数

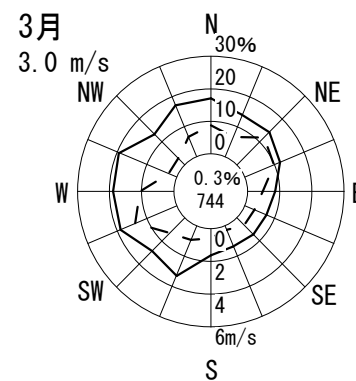
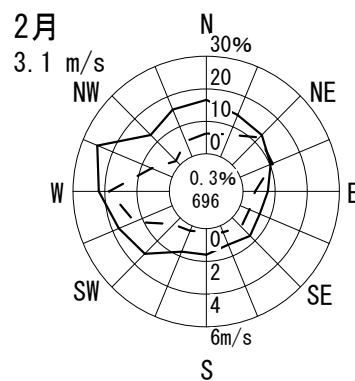
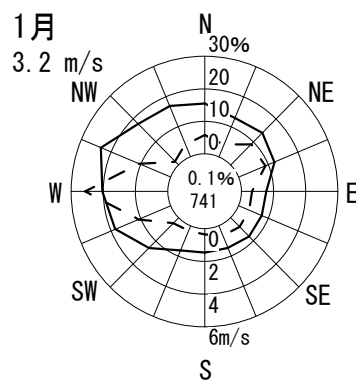
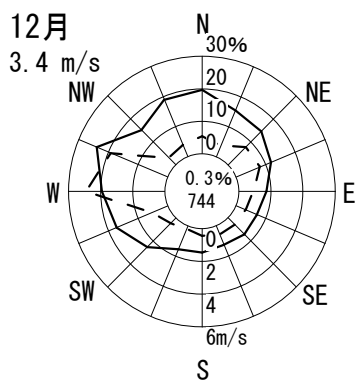
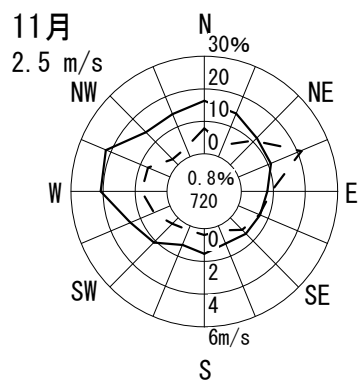
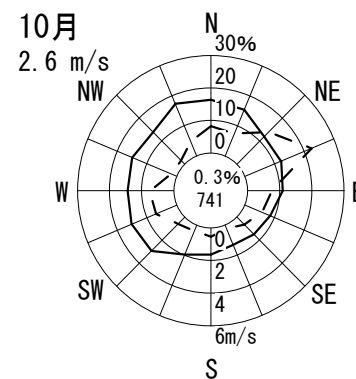
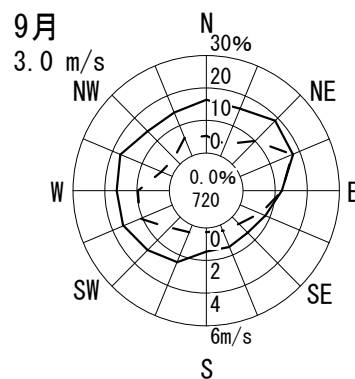
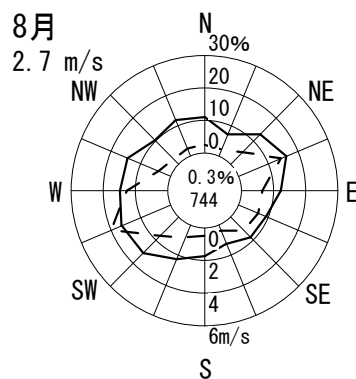
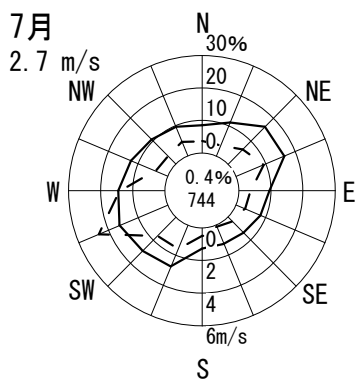
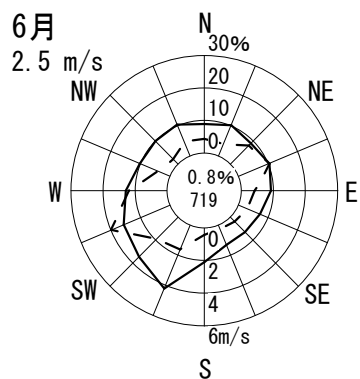
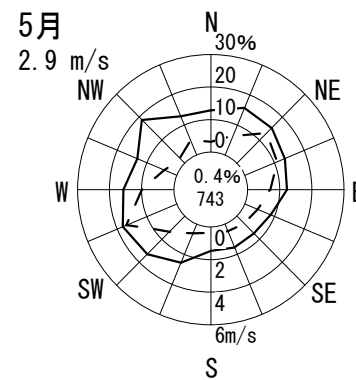
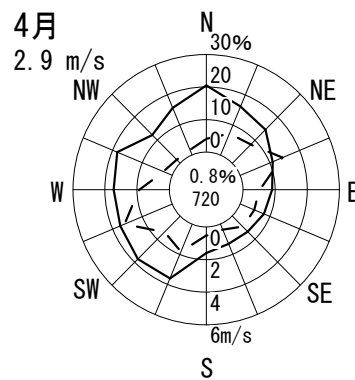
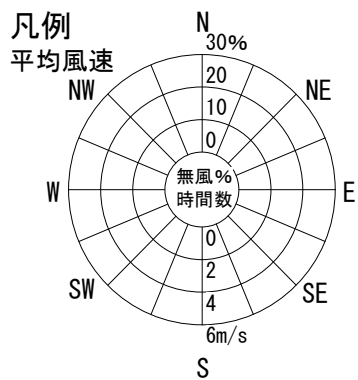
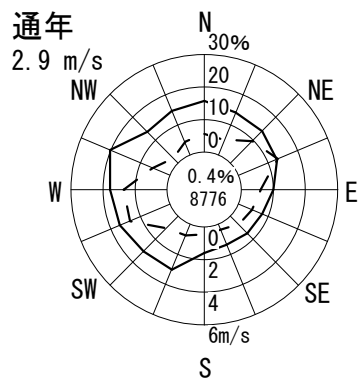

# 風配図 - 月別

測定局：金岡

2011年4月～2012年3月 1～24 時  
風向風速計高さ 18.0 m

--- 出現頻度  
—— 平均風速

円内 無風%  
測定時間数

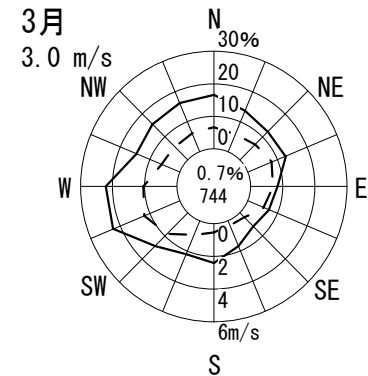
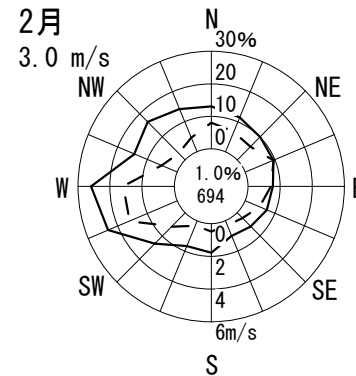
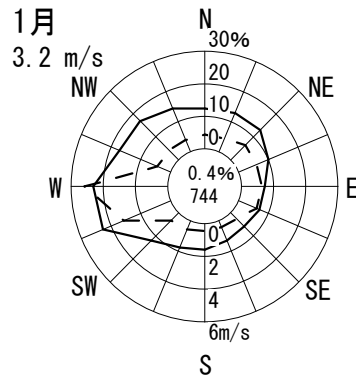
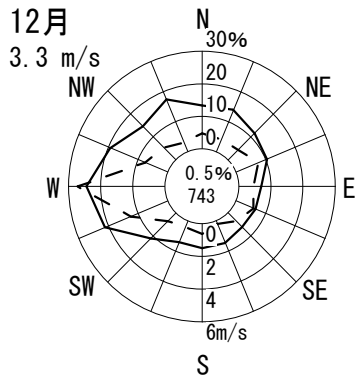
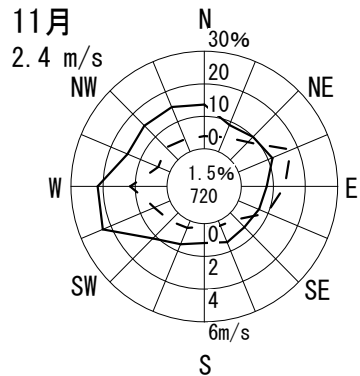
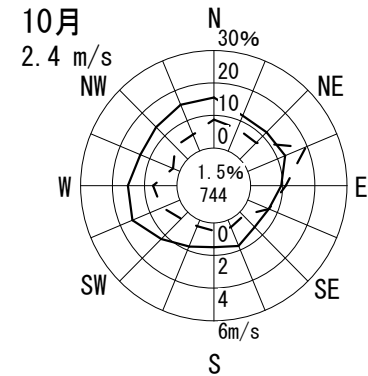
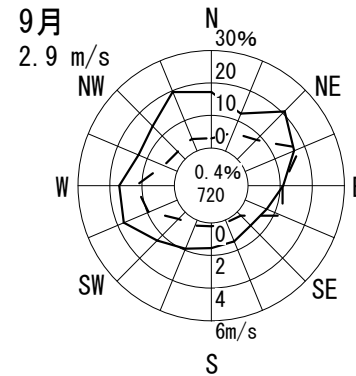
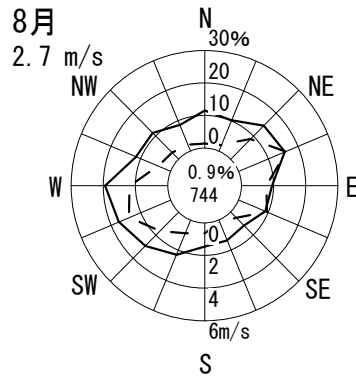
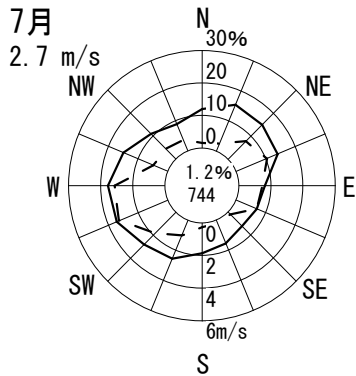
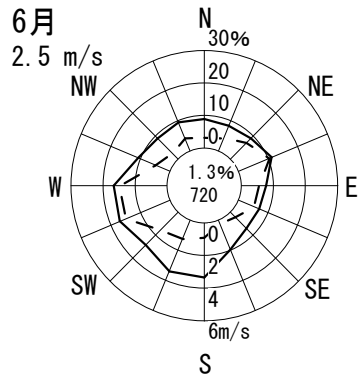
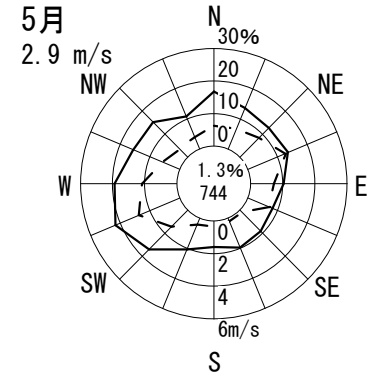
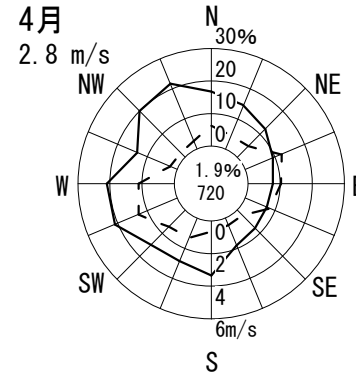
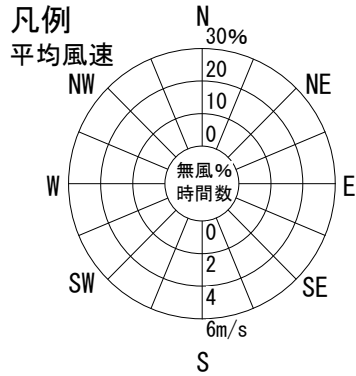
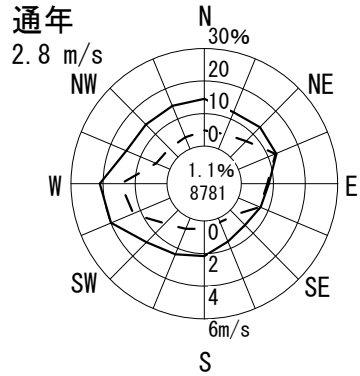



# 風配図 - 月別

測定局：三宝

2011年4月～2012年3月 1～24 時

風向風速計高さ 6.0 m

--- 出現頻度

— 平均風速

円内 無風%  
測定時間数

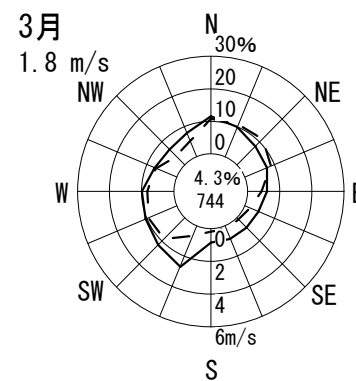
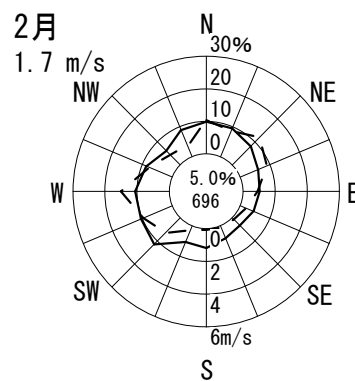
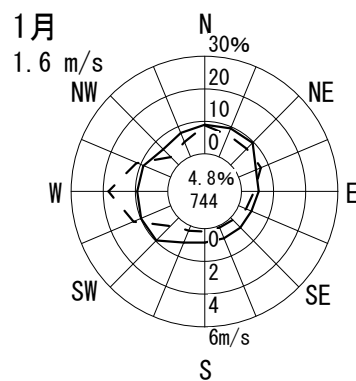
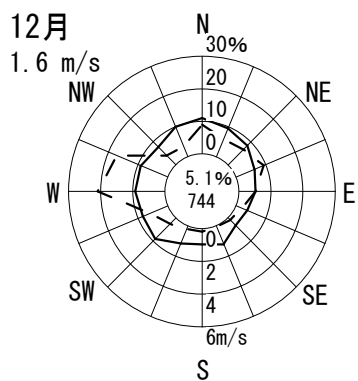
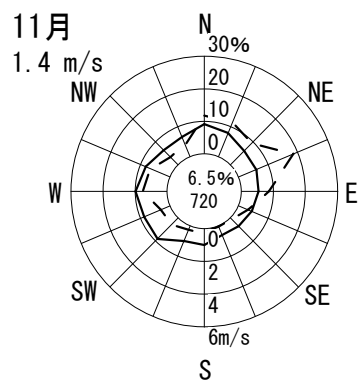
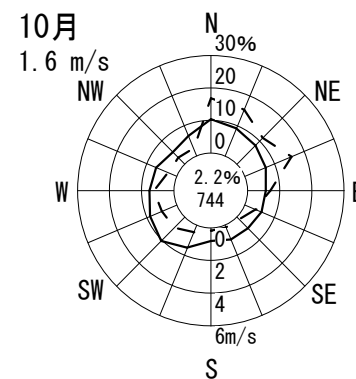
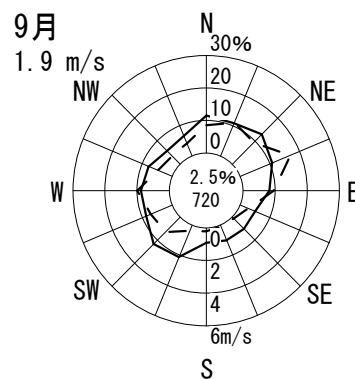
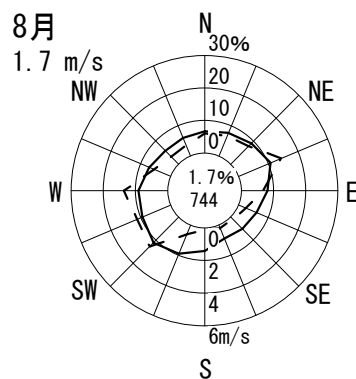
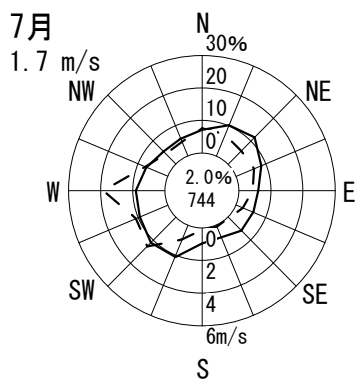
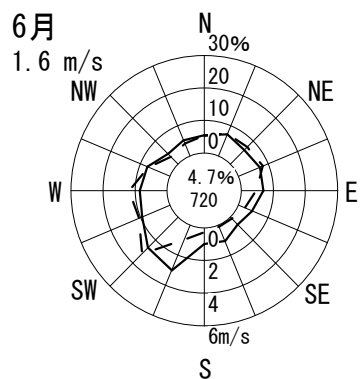
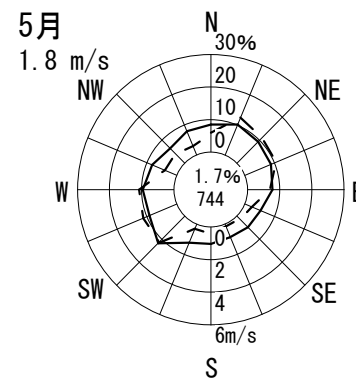
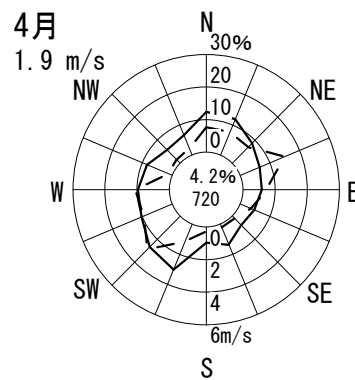
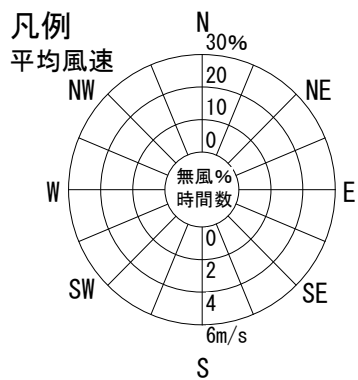
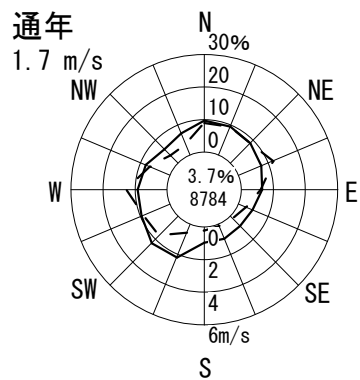

# 風配図 - 月別

測定局：若松台

2011年4月～2012年3月 1～24 時

風向風速計高さ 18.0 m

--- 出現頻度  
—— 平均風速

円内 無風%  
測定時間数

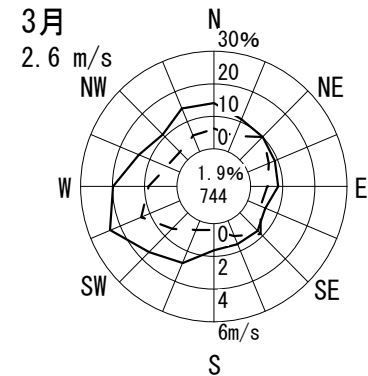
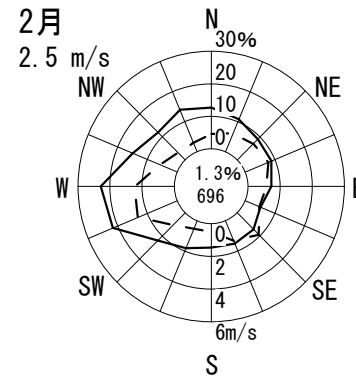
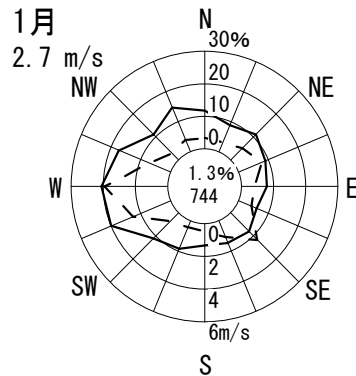
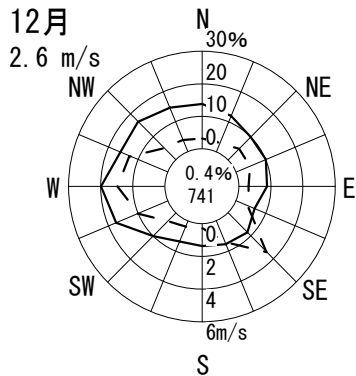
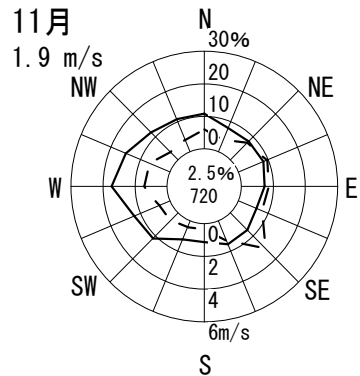
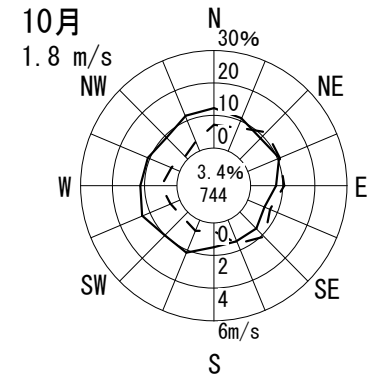
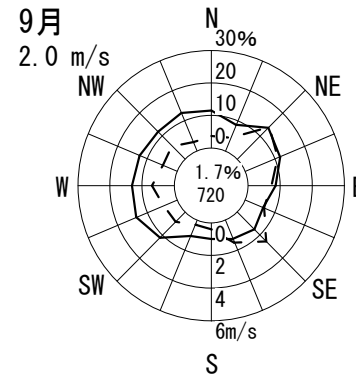
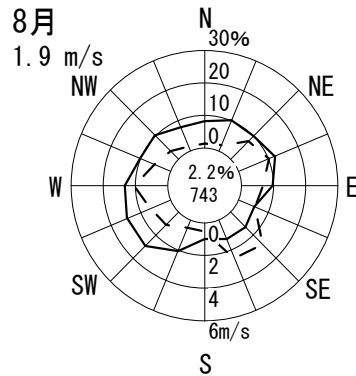
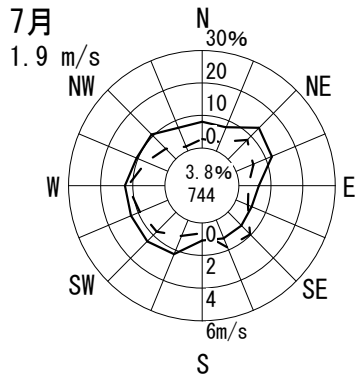
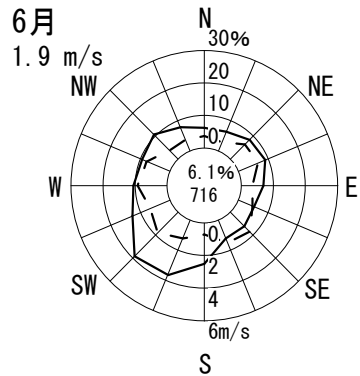
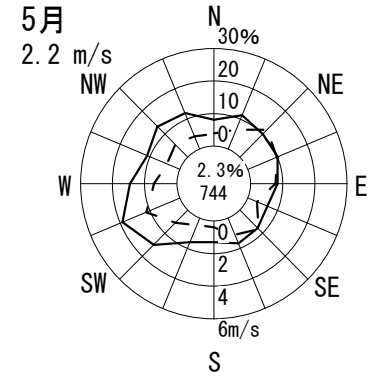
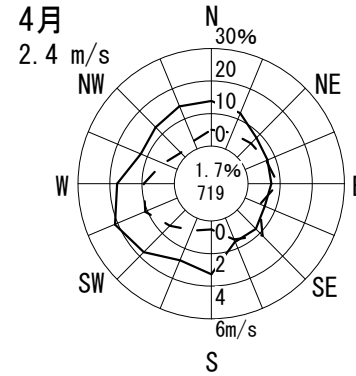
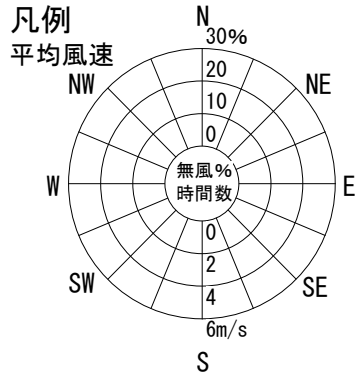
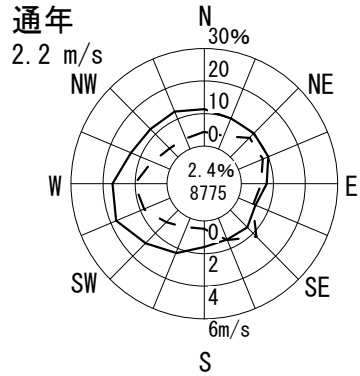

# 風配図 - 月別

測定局：登美丘

2011年4月～2012年3月 1～24 時  
風向風速計高さ 18.0 m

--- 出現頻度  
—— 平均風速

円内 無風%  
測定時間数

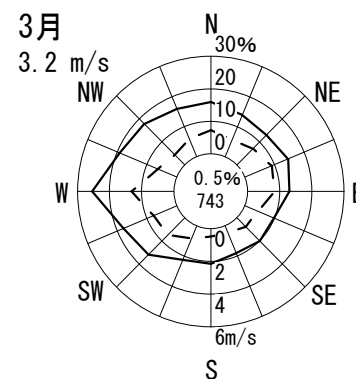
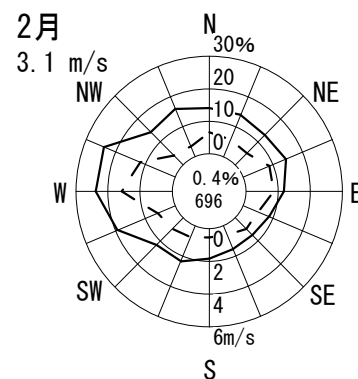
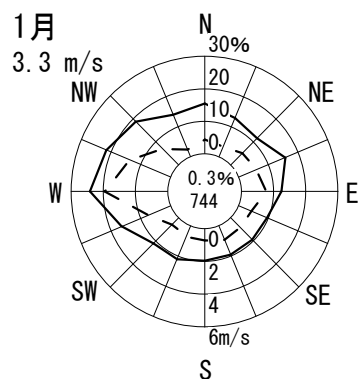
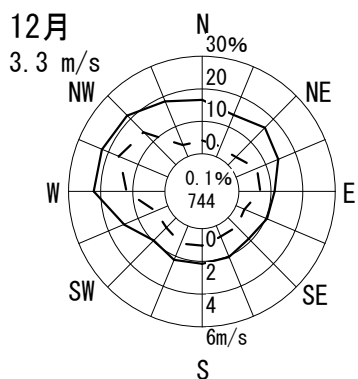
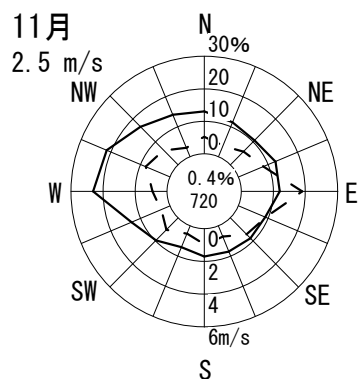
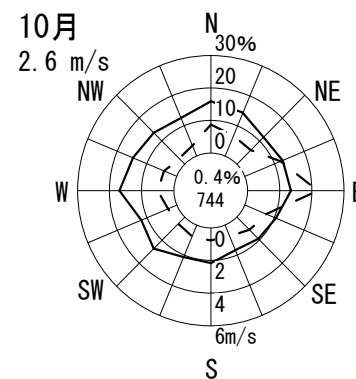
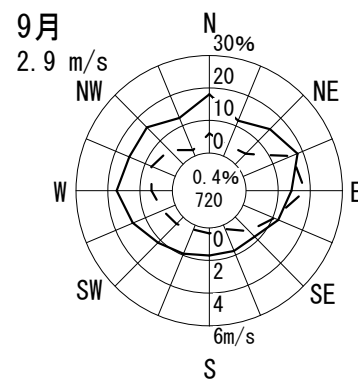
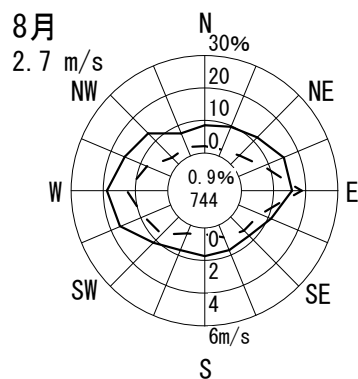
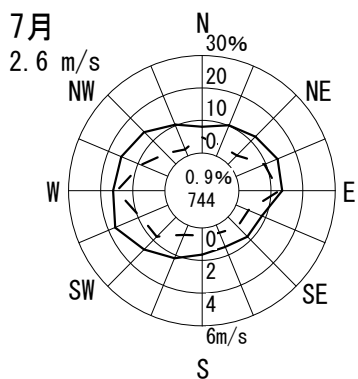
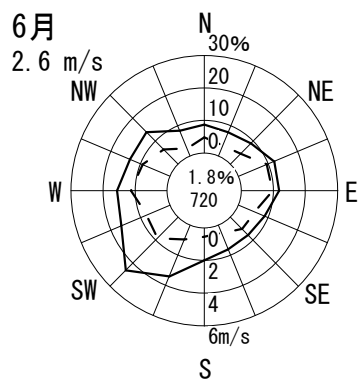
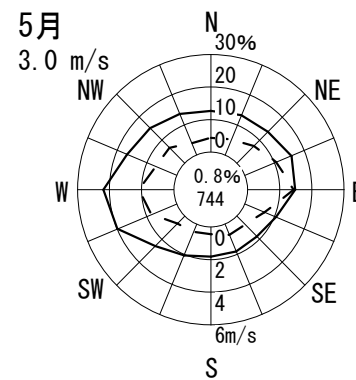
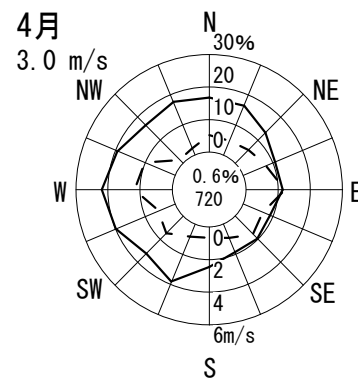
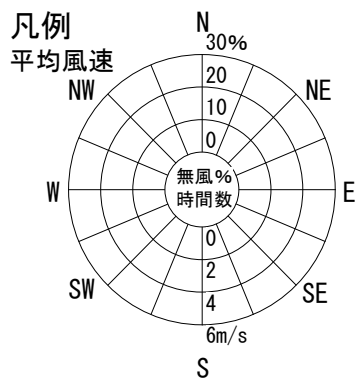
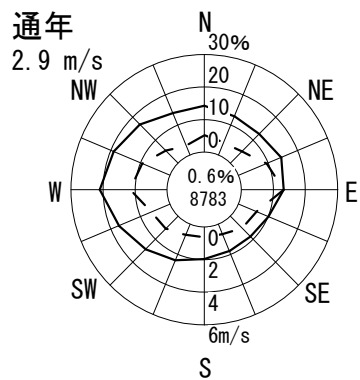

# 風配図 - 月別

測定局：深井

2011年4月～2012年3月 1～24 時  
風向風速計高さ 19.0 m

--- 出現頻度  
—— 平均風速

円内 無風%  
測定時間数

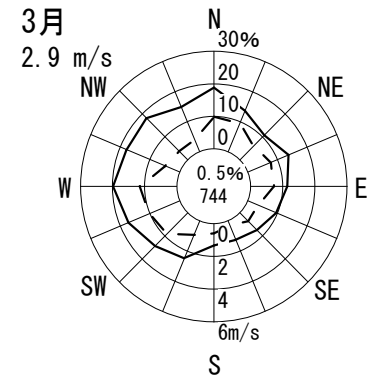
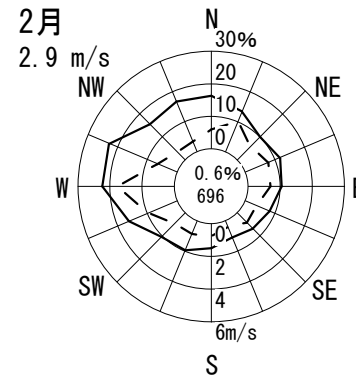
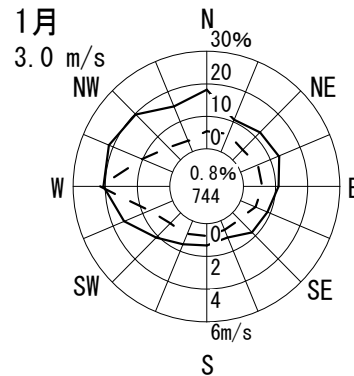
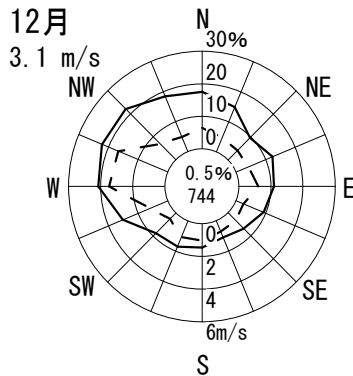
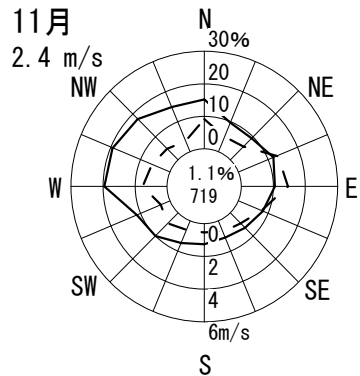
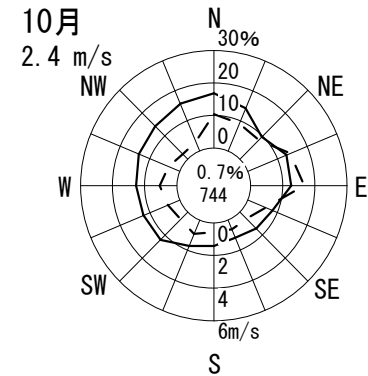
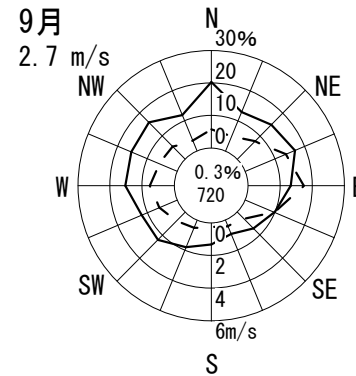
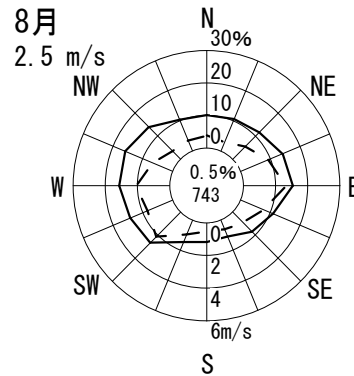
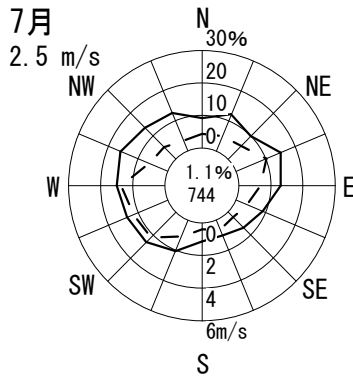
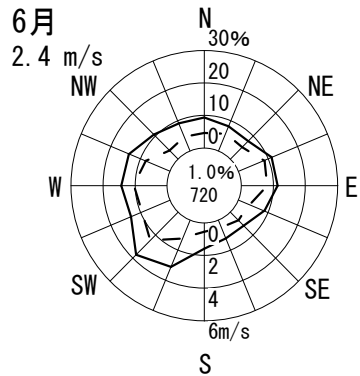
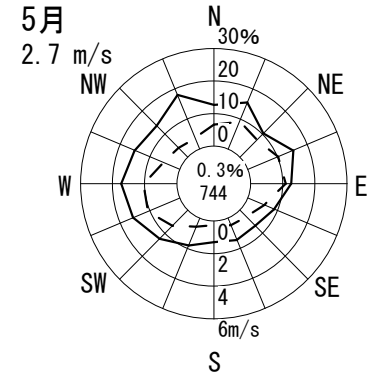
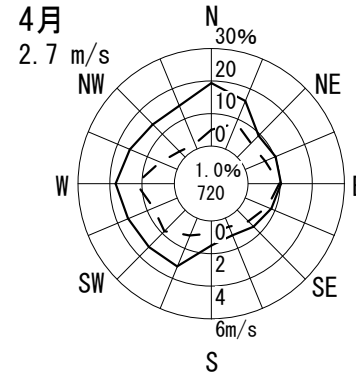
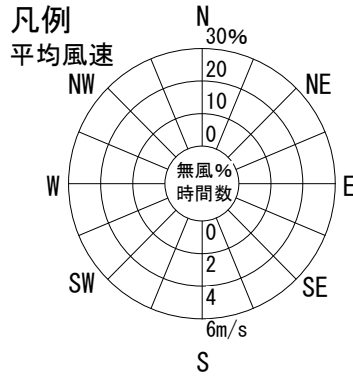
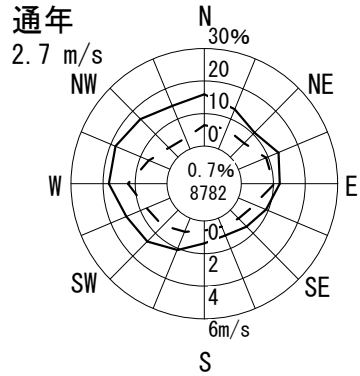

# 風配図 - 月別

測定局：美原

2011年4月～2012年3月 1～24 時  
風向風速計高さ 10.0 m

--- 出現頻度  
— 平均風速

円内 無風%  
測定時間数

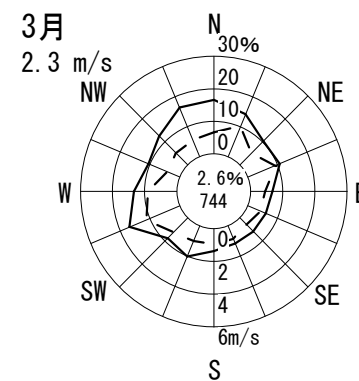
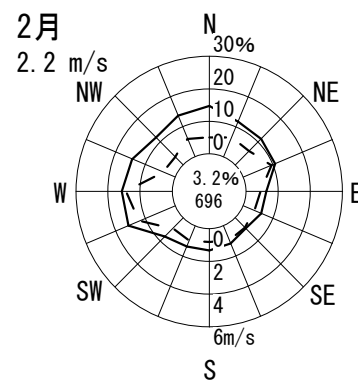
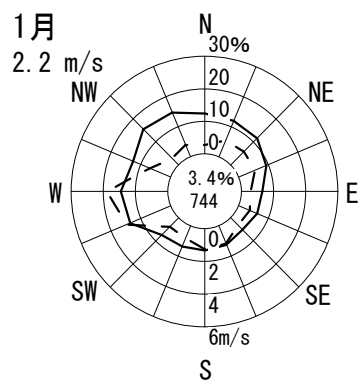
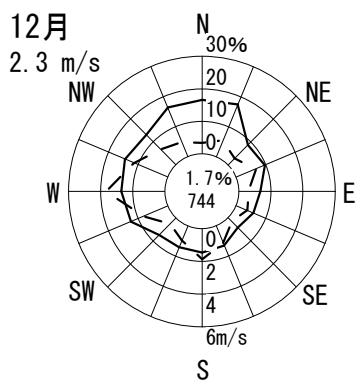
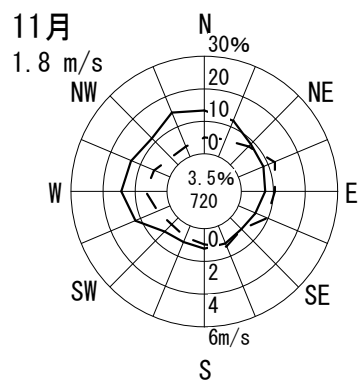
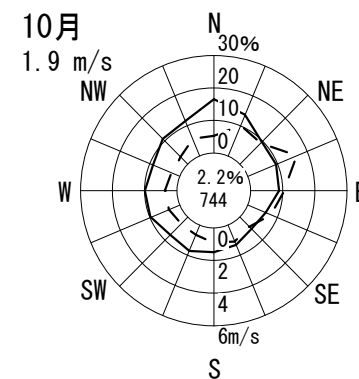
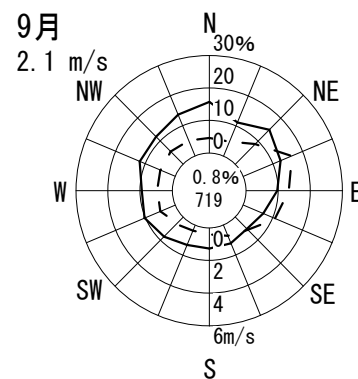
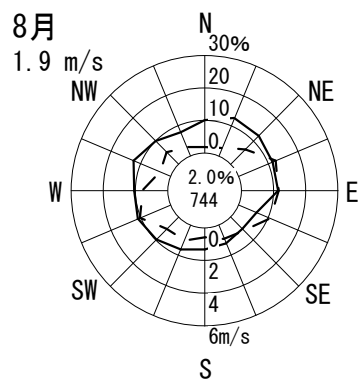
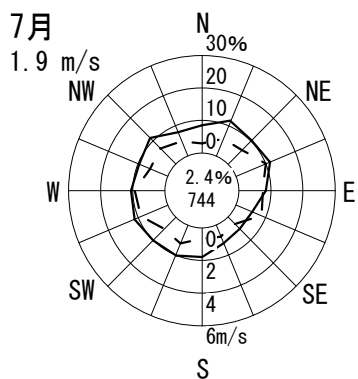
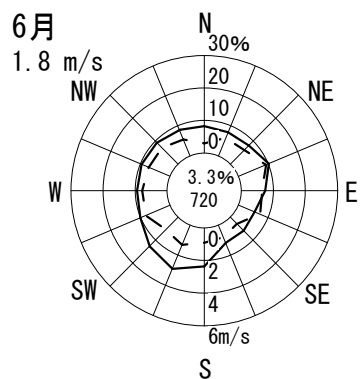
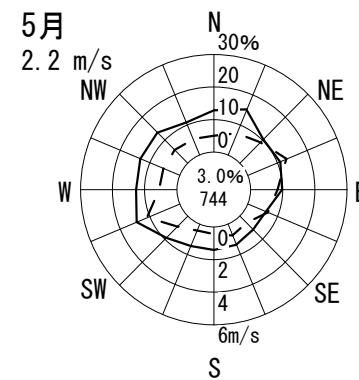
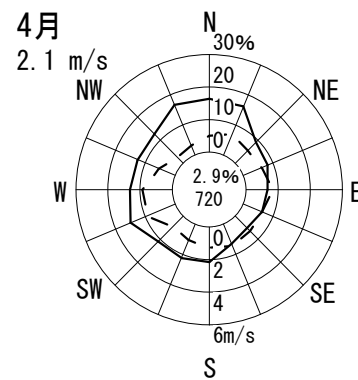
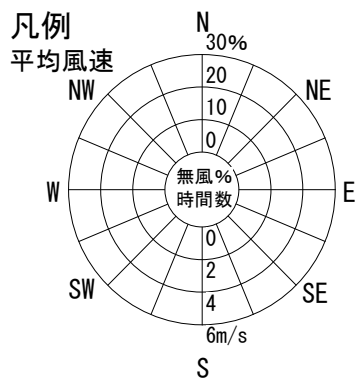
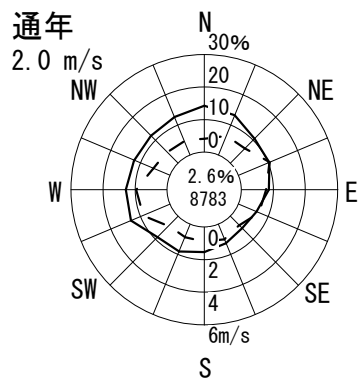

# 風配図 - 月別

測定局：岸和田中央公園

2011年4月～2012年3月 1～24 時

風向風速計高さ 10.3 m

--- 出現頻度

— 平均風速

円内 無風%  
測定時間数

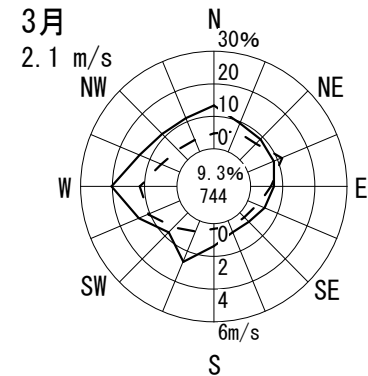
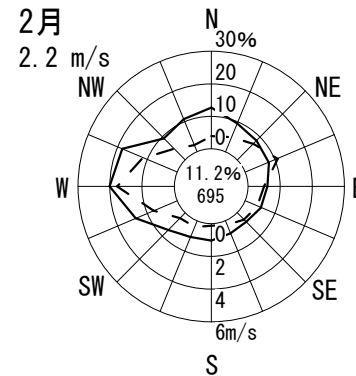
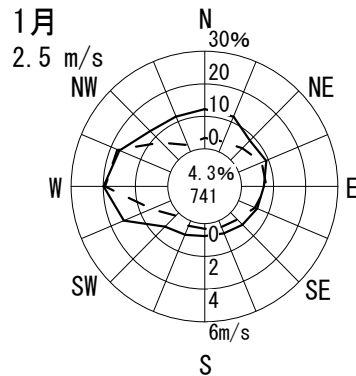
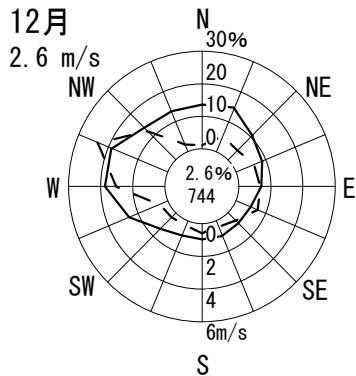
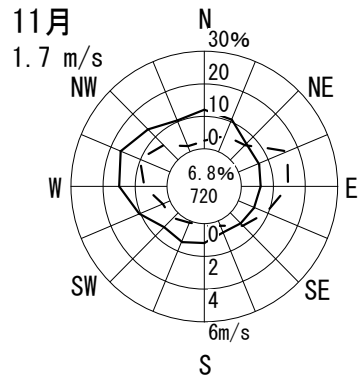
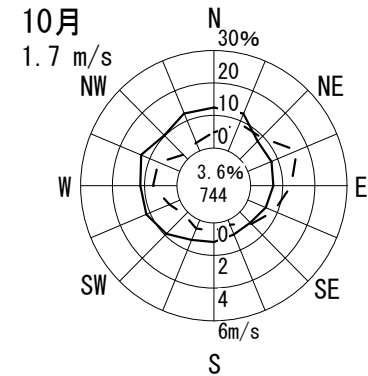
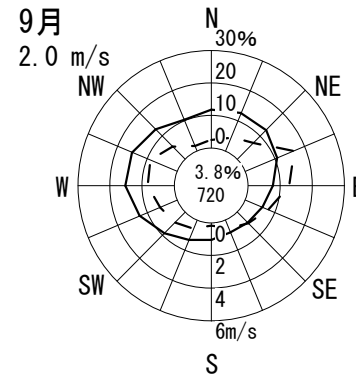
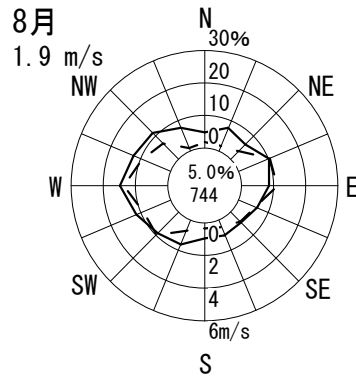
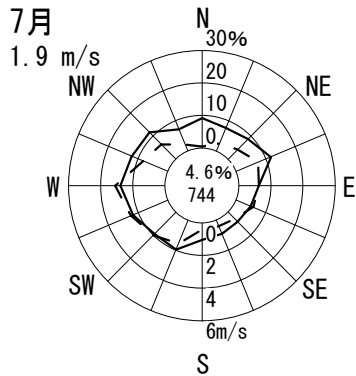
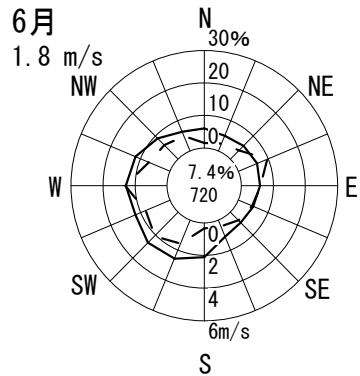
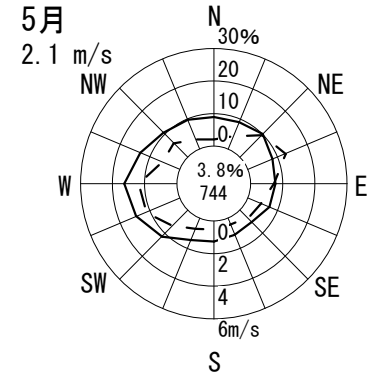
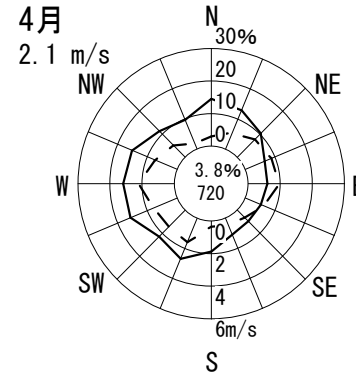
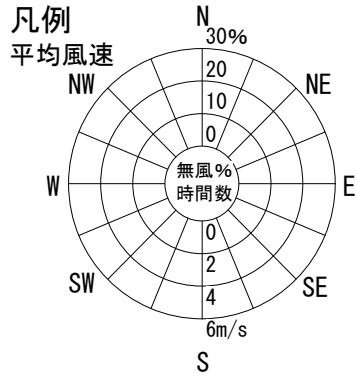
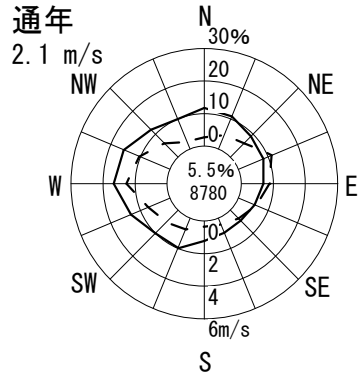

# 風配図 - 月別

測定局：千成

2011年4月～2012年3月 1～24 時  
風向風速計高さ 8.0 m

--- 出現頻度  
—— 平均風速

円内 無風%  
測定時間数

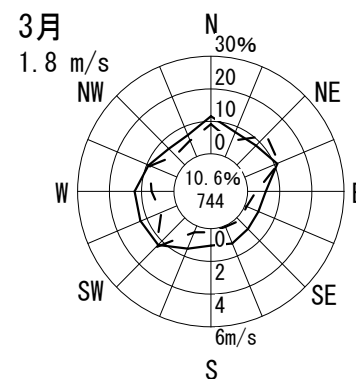
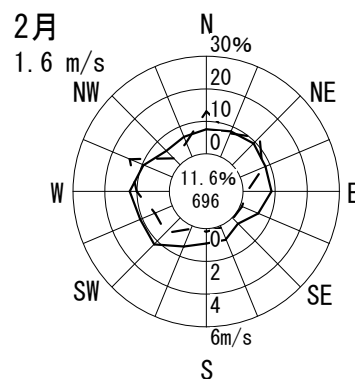
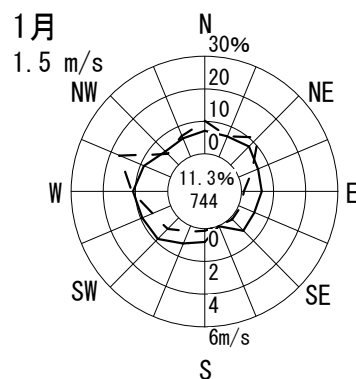
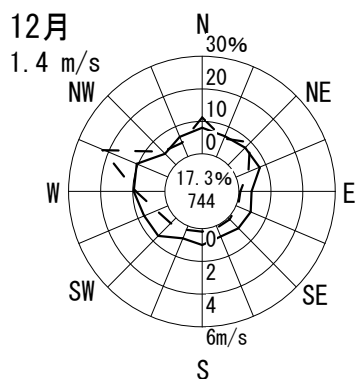
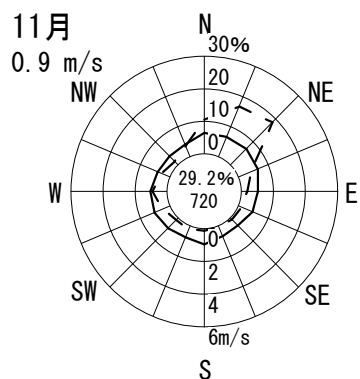
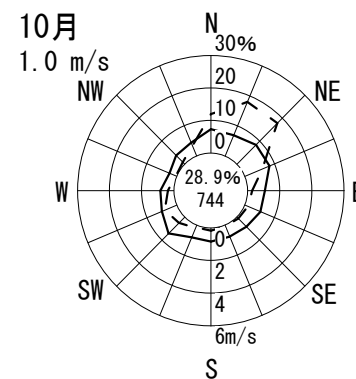
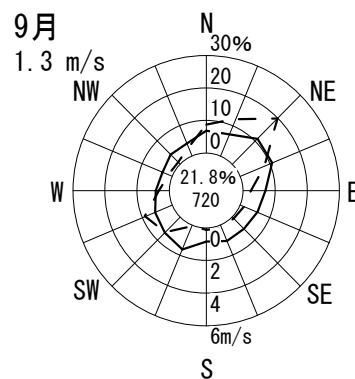
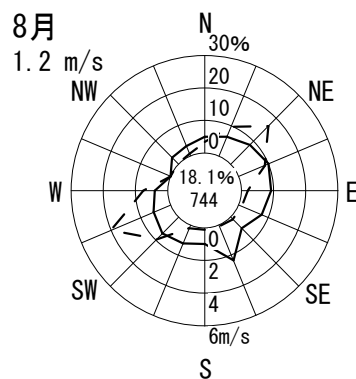
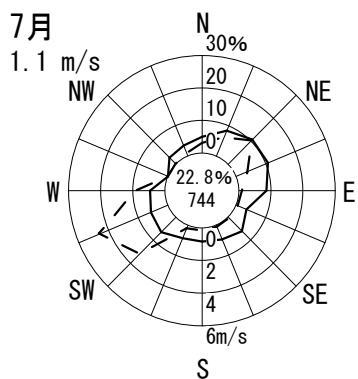
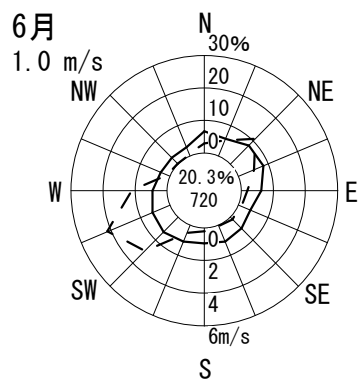
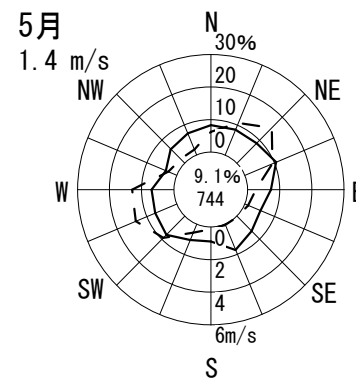
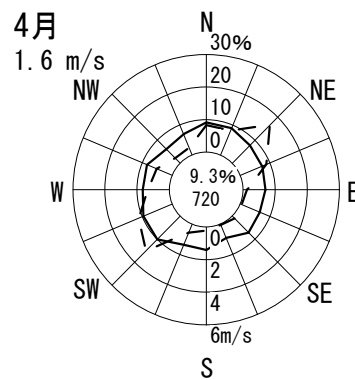
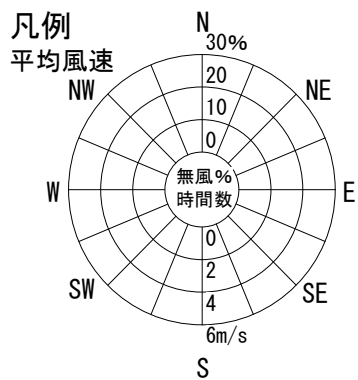
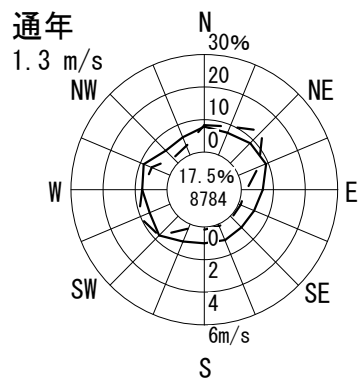

# 風配図 - 月別

測定局：池田市立南畑会館

2011年4月～2012年3月 1～24 時

風向風速計高さ 14.6 m

--- 出現頻度

— 平均風速

円内 無風%  
測定時間数

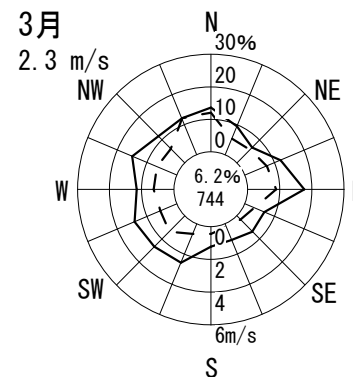
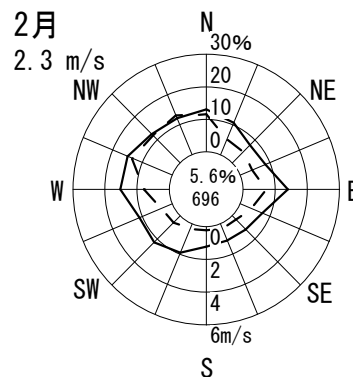
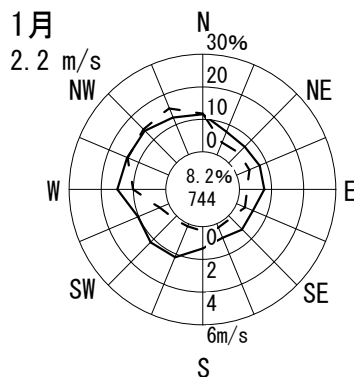
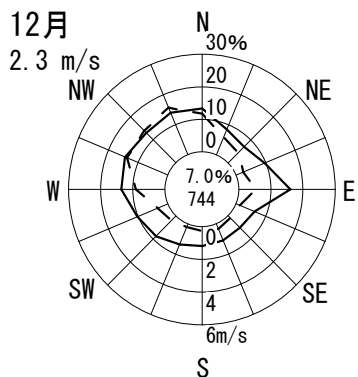
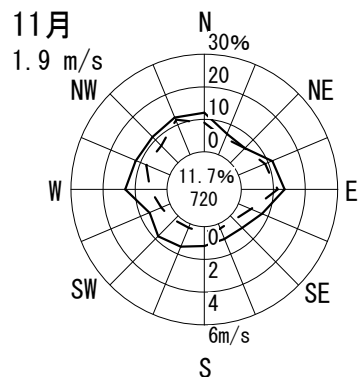
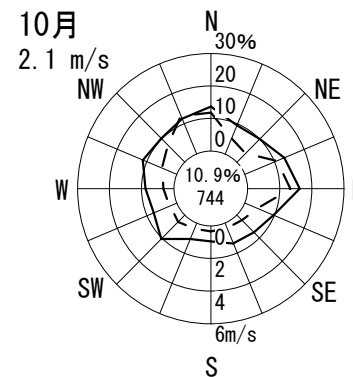
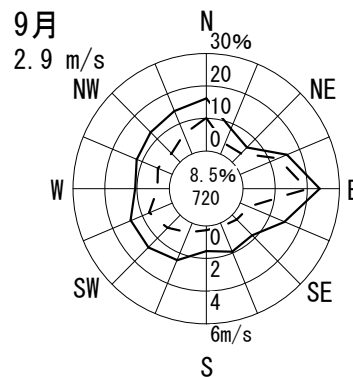
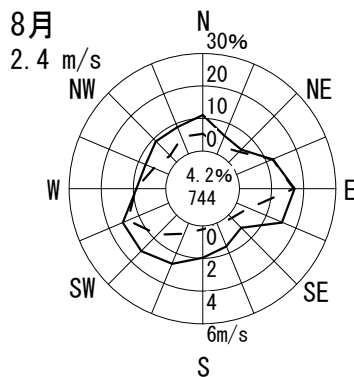
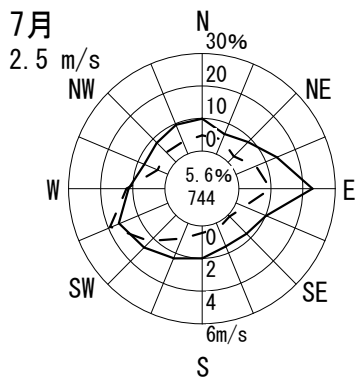
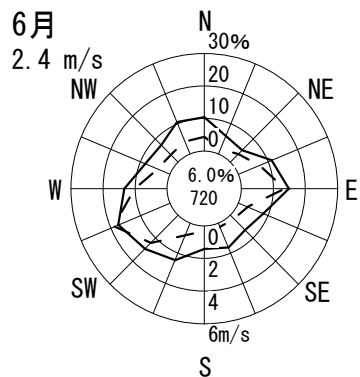
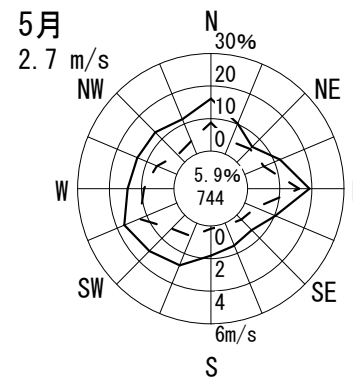
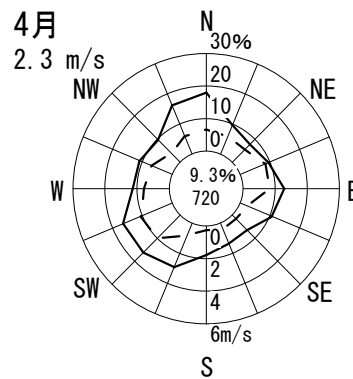
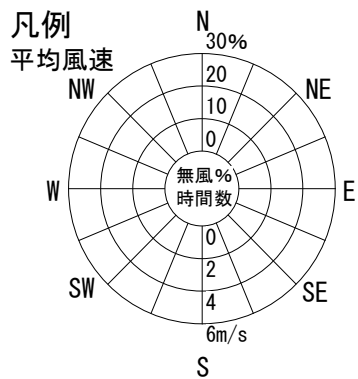
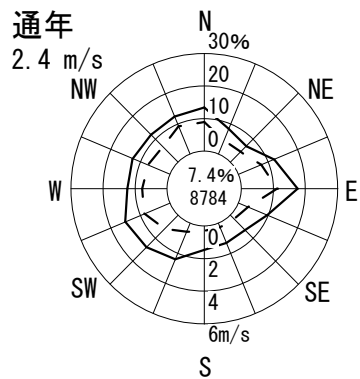



# 風配図 - 月別

測定局：吹田市垂水

2011年4月～2012年3月 1～24 時

風向風速計高さ 24.0 m

--- 出現頻度

— 平均風速

円内 無風%  
測定時間数

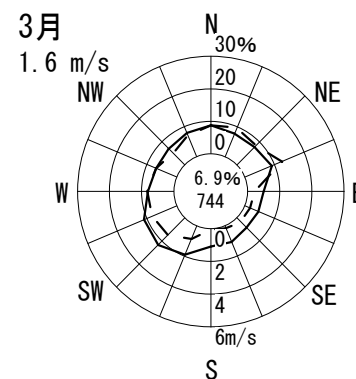
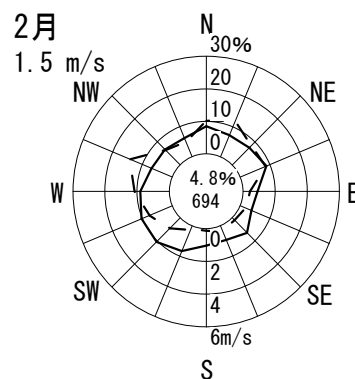
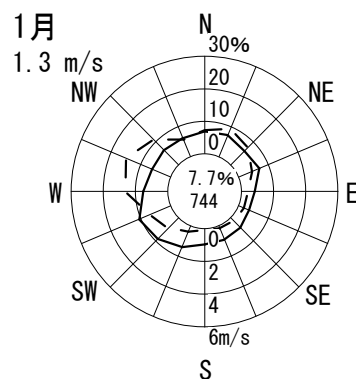
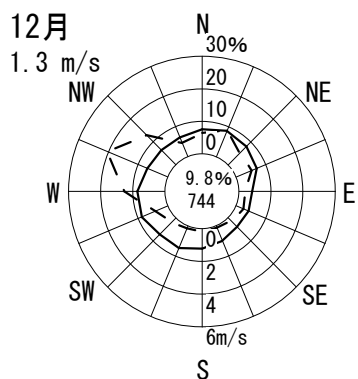
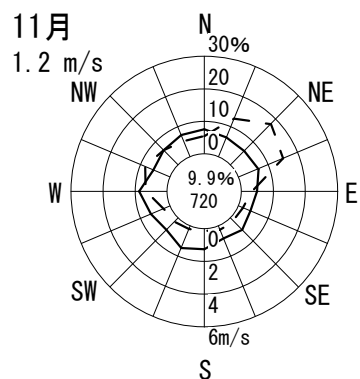
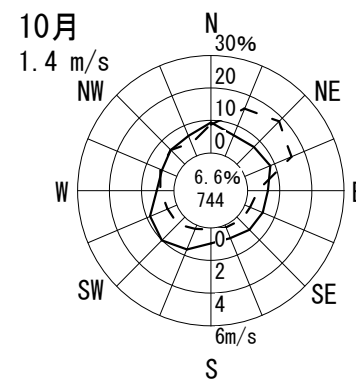
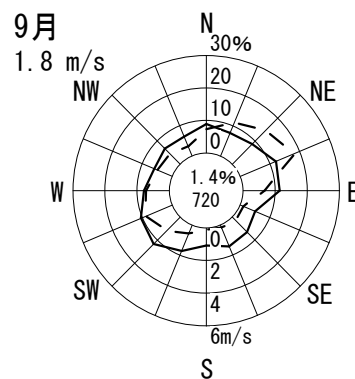
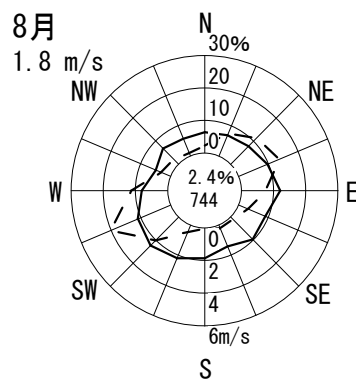
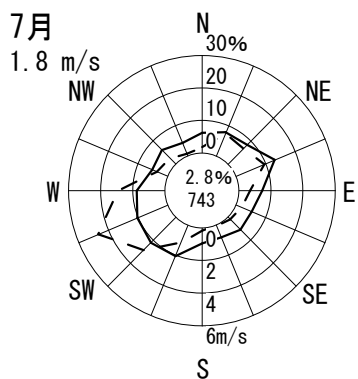
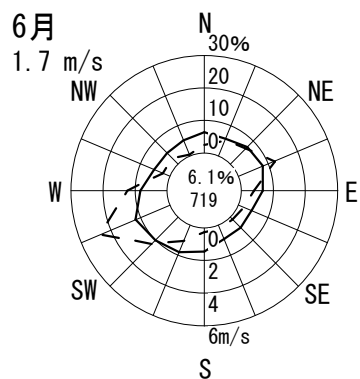
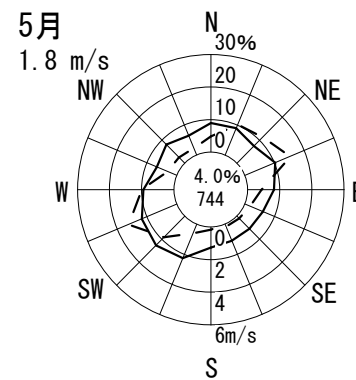
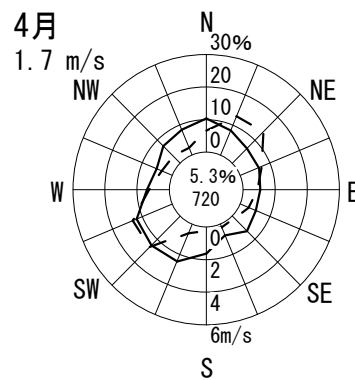
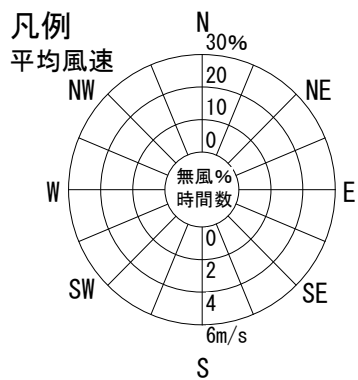
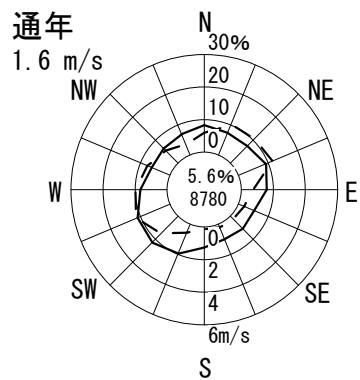

# 風配図 - 月別

測定局：吹田市北消防署

2011年4月～2012年3月 1～24 時

風向風速計高さ 14.0 m

--- 出現頻度

— 平均風速

円内 無風%  
測定時間数

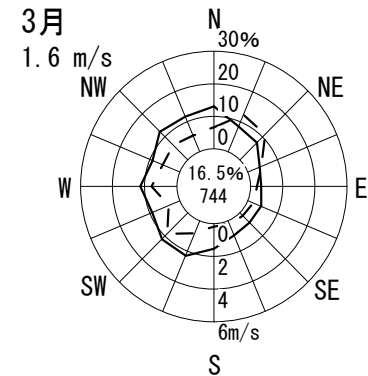
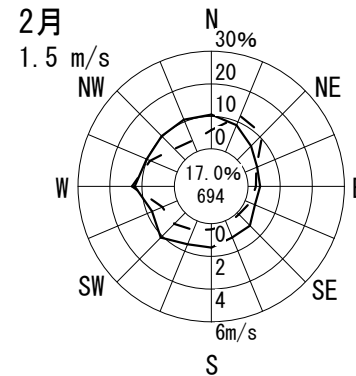
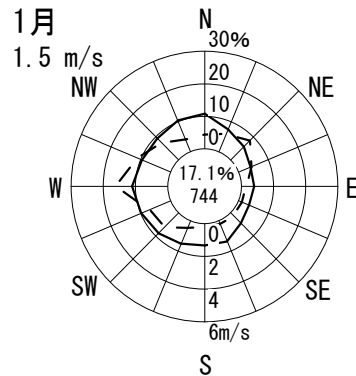
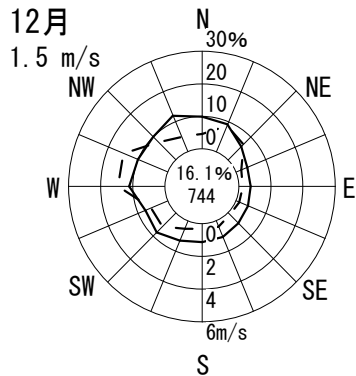
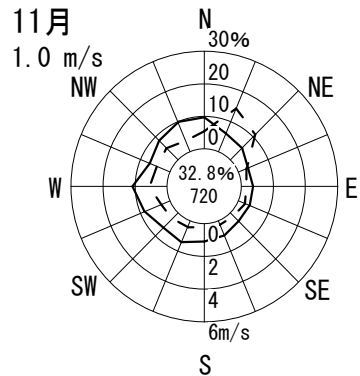
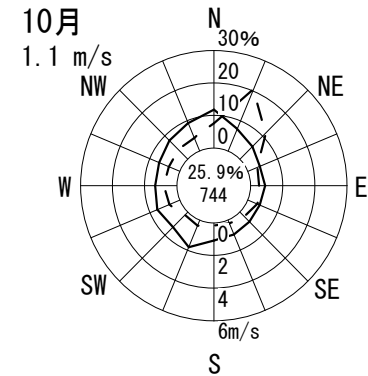
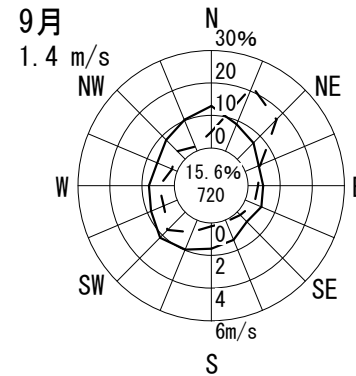
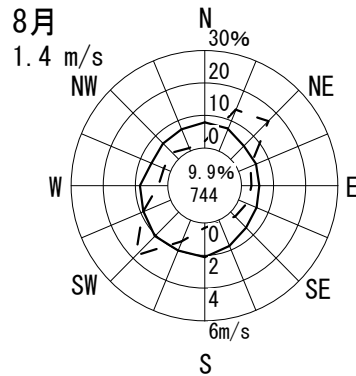
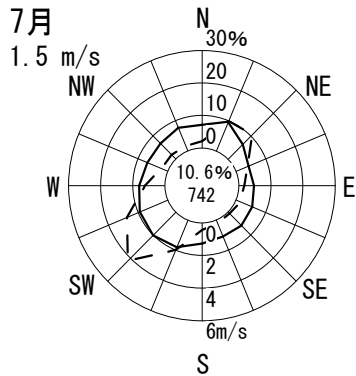
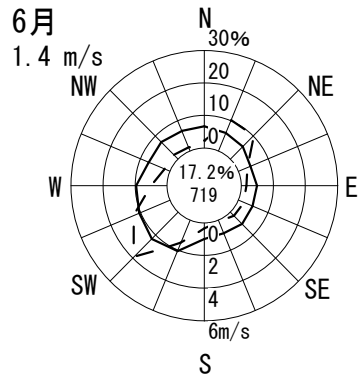
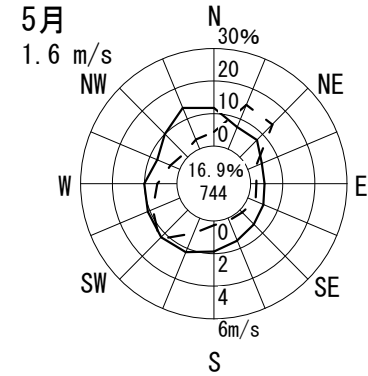
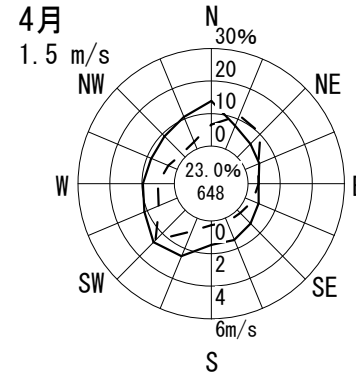
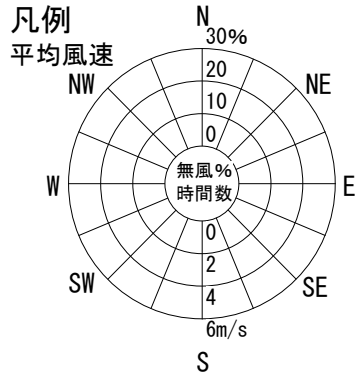
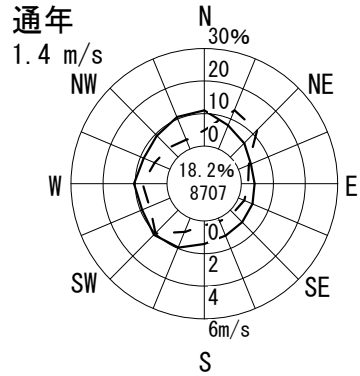

# 風配図 - 月別

測定局：吹田市川園

2011年4月～2012年3月 1～24 時

風向風速計高さ 15.5 m

--- 出現頻度

— 平均風速

○内 無風%  
測定時間数

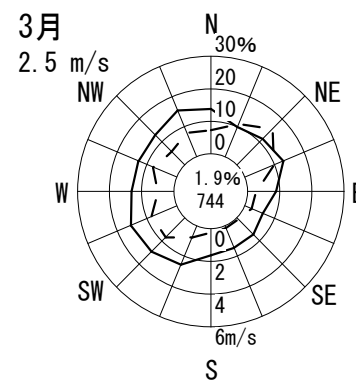
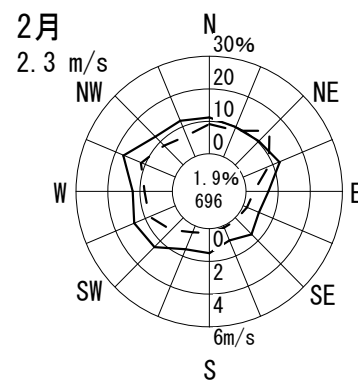
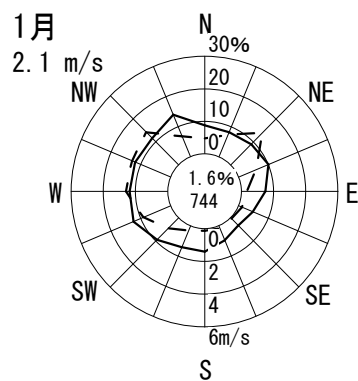
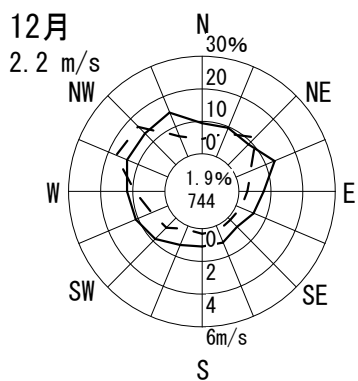
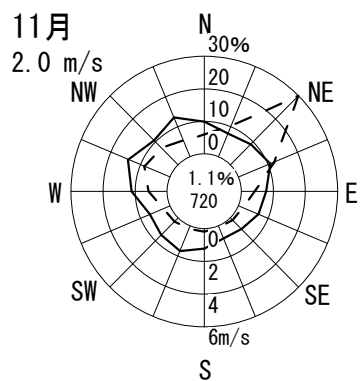
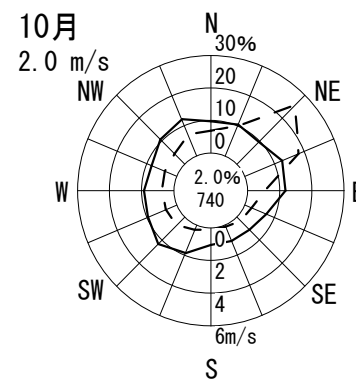
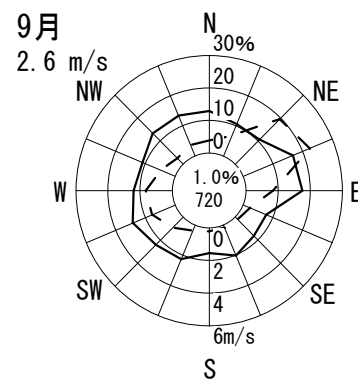
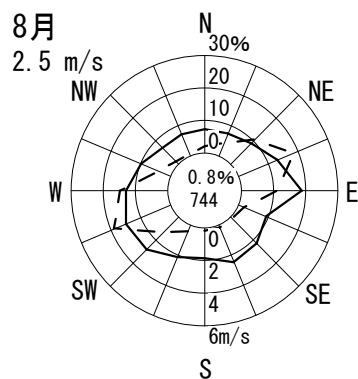
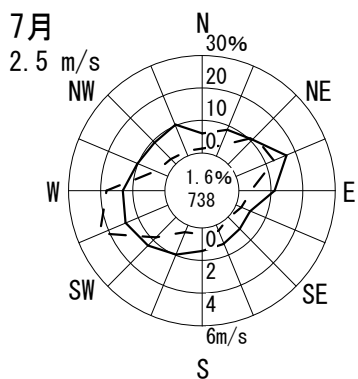
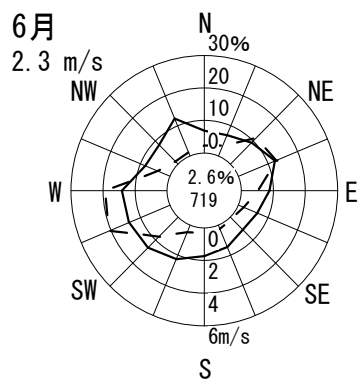
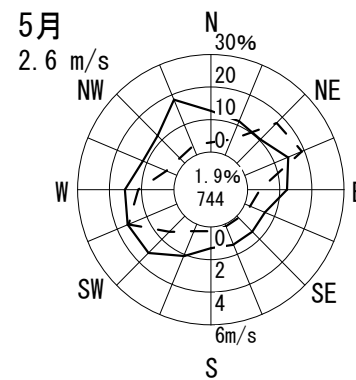
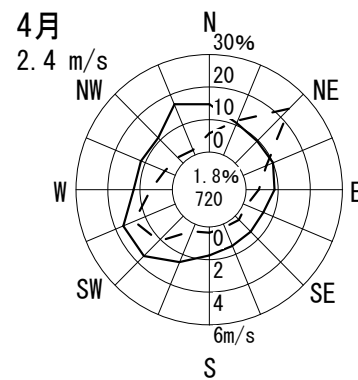
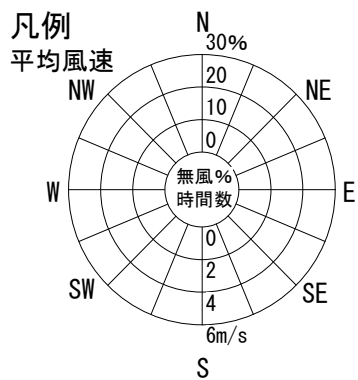
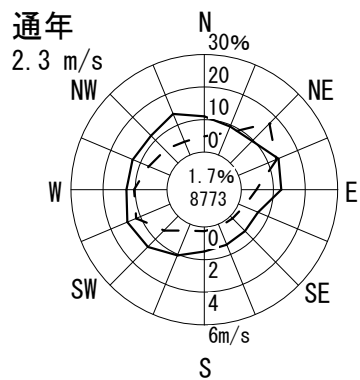

# 風配図 - 月別

測定局：泉大津市役所

2011年4月～2012年3月 1～24 時

風向風速計高さ 24.0 m

--- 出現頻度  
—— 平均風速

円内 無風%  
測定時間数

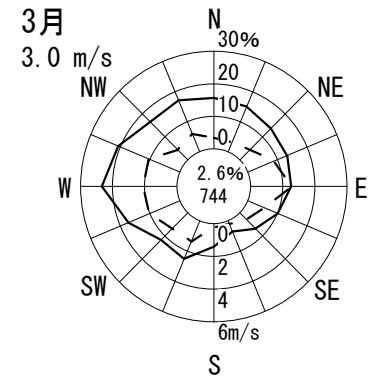
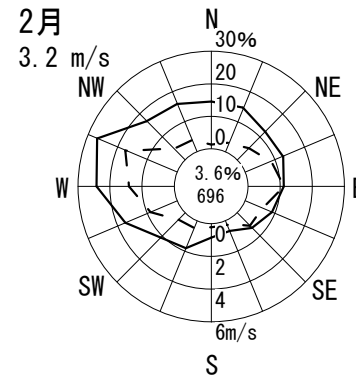
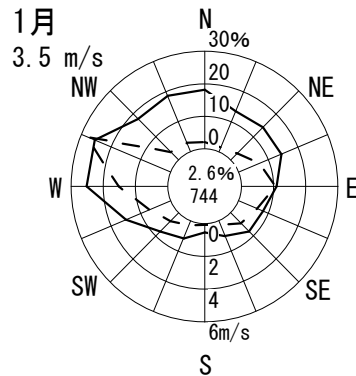
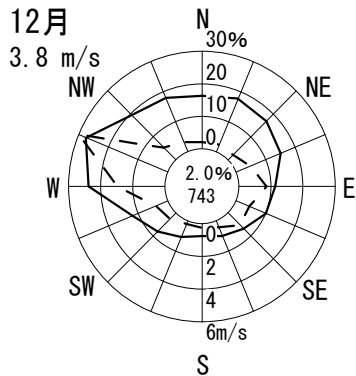
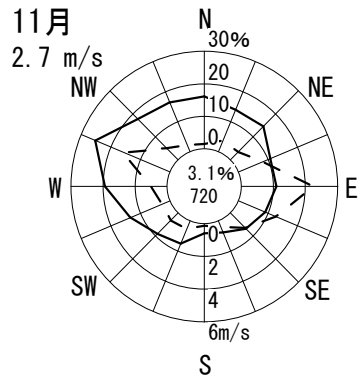
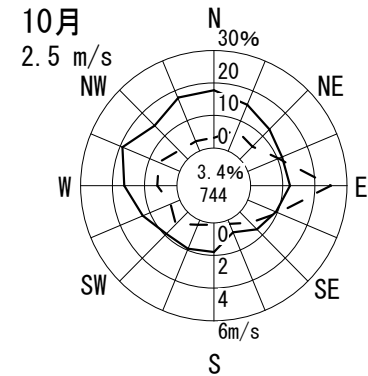
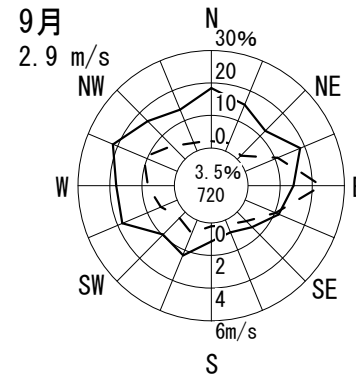
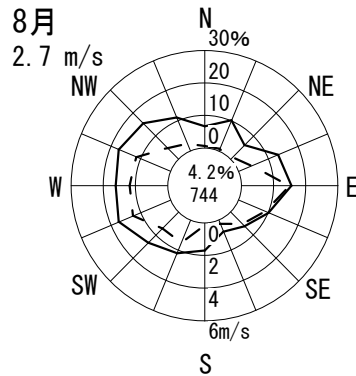
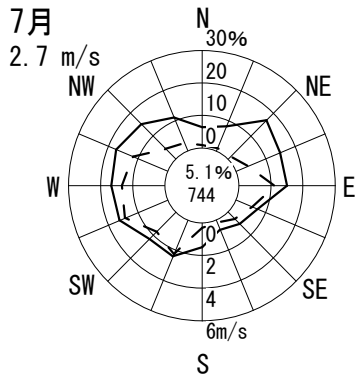
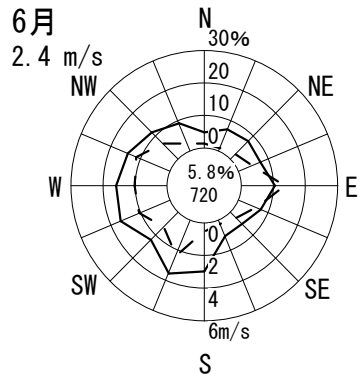
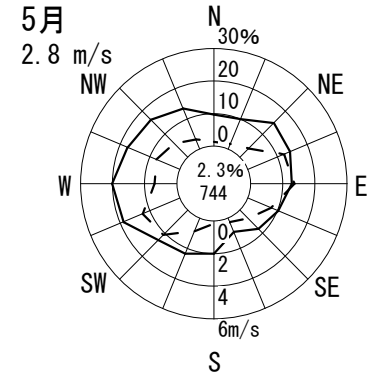
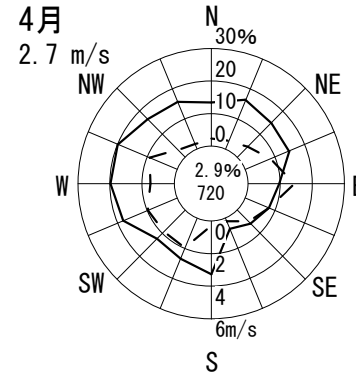
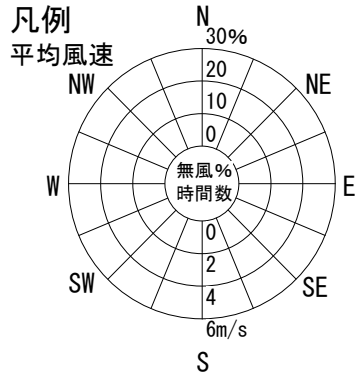
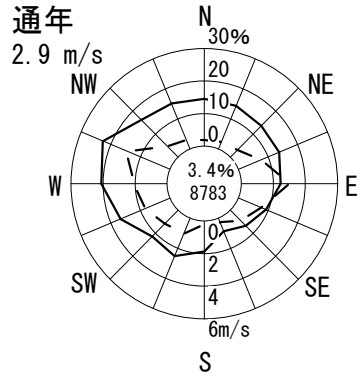

# 風配図 - 月別

測定局：高槻南

2011年4月～2012年3月 1～24 時

風向風速計高さ 8.0 m

--- 出現頻度

— 平均風速

円内 無風%  
測定時間数

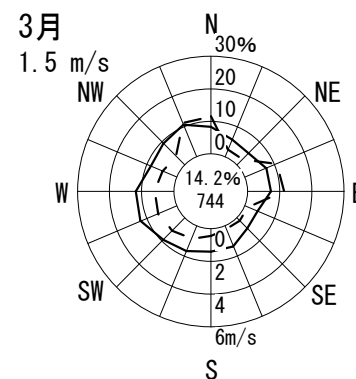
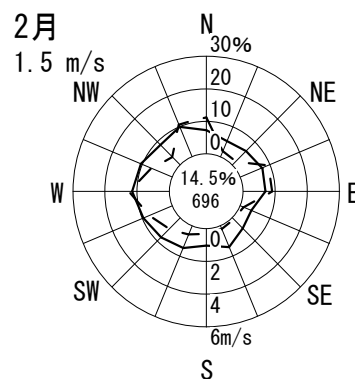
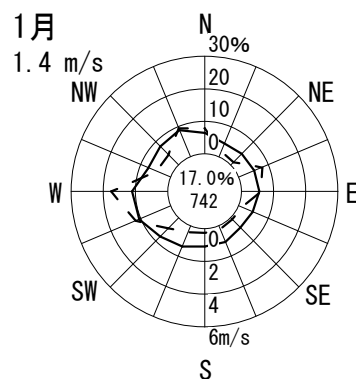
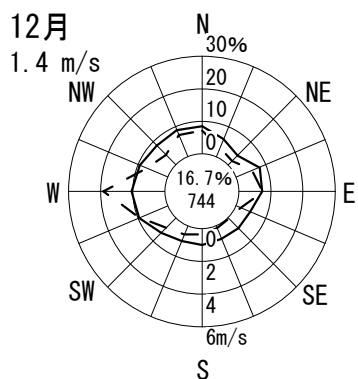
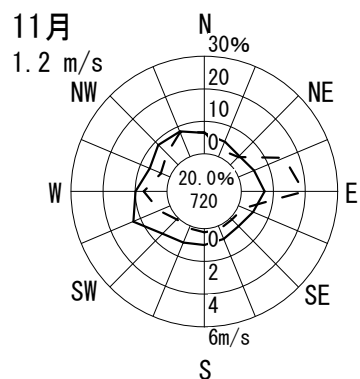
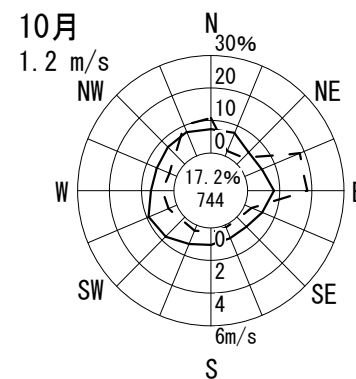
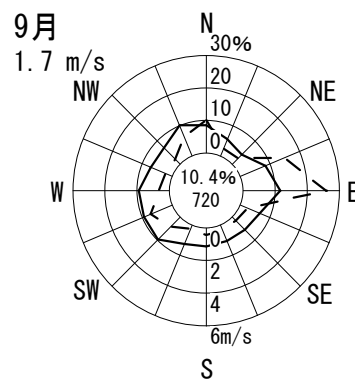
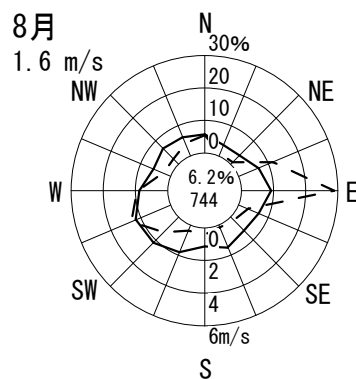
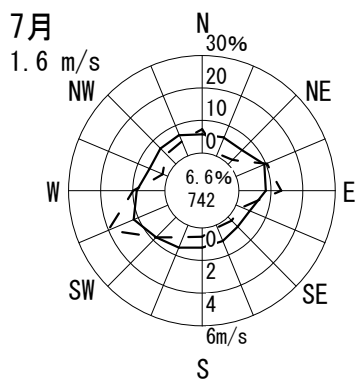
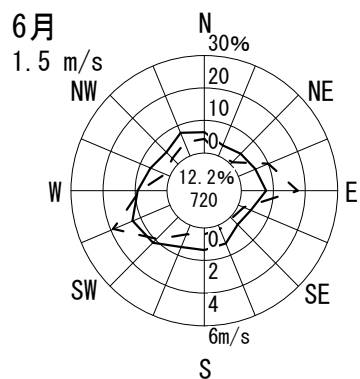
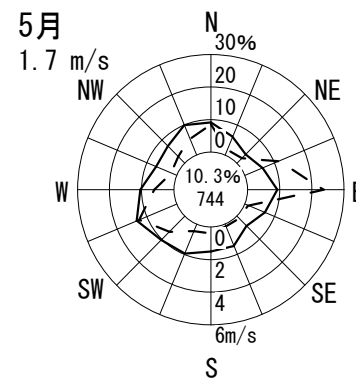
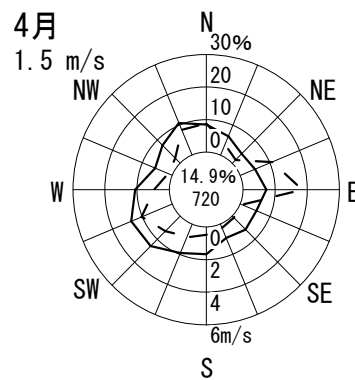
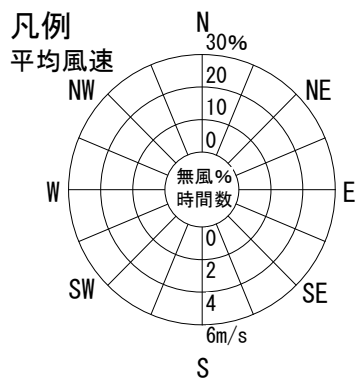
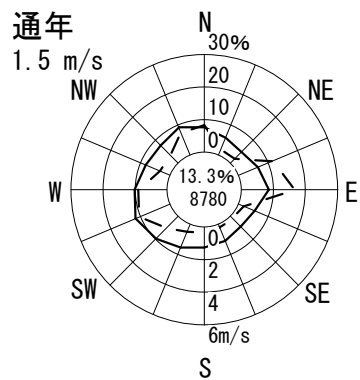

# 風配図 - 月別

測定局：高槻北

2011年4月～2012年3月 1～24 時

風向風速計高さ 13.0 m

--- 出現頻度  
—— 平均風速

円内 無風%  
測定時間数

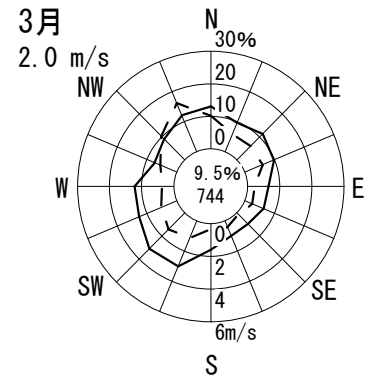
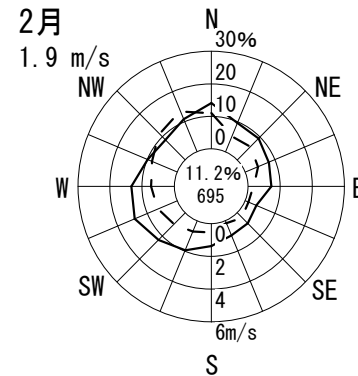
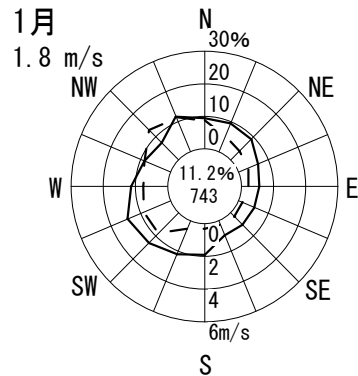
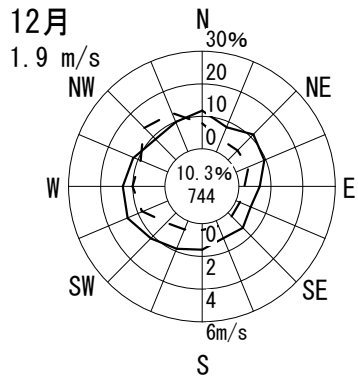
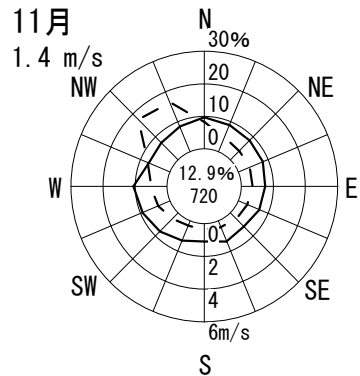
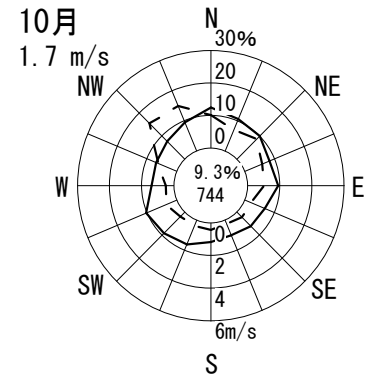
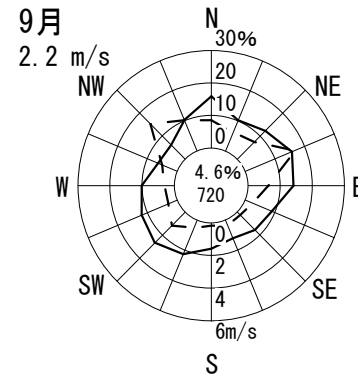
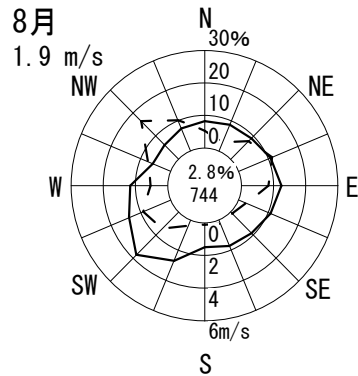
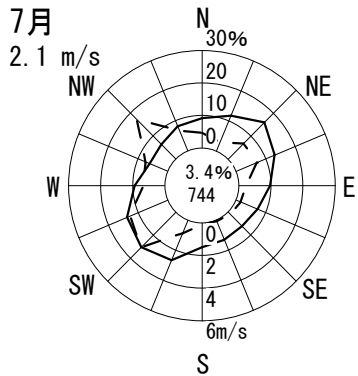
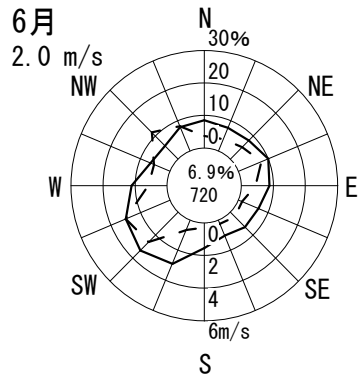
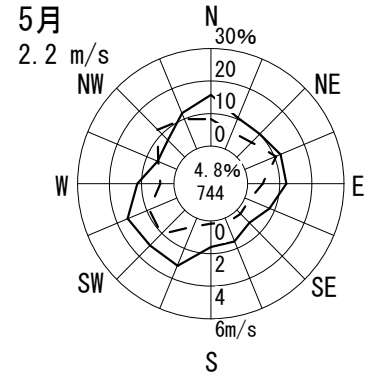
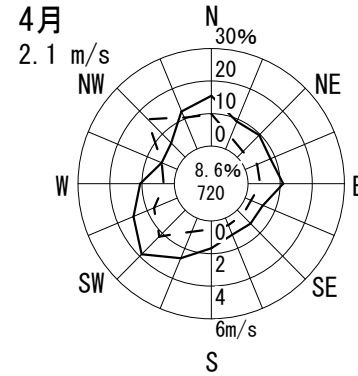
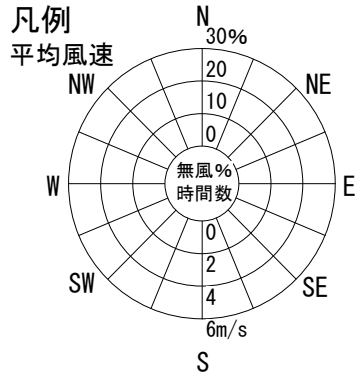
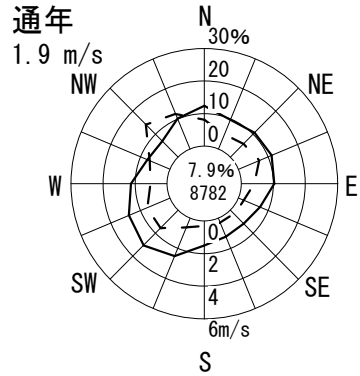

# 風配図 - 月別

測定局：貝塚市消防署

2011年4月～2012年3月 1～24 時

風向風速計高さ 22.5 m

--- 出現頻度

— 平均風速

円内 無風%  
測定時間数

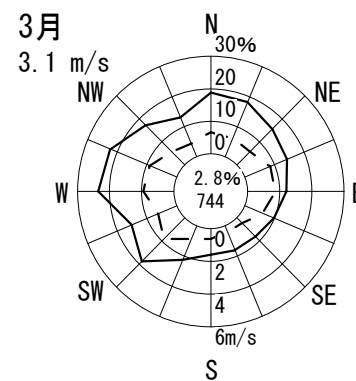
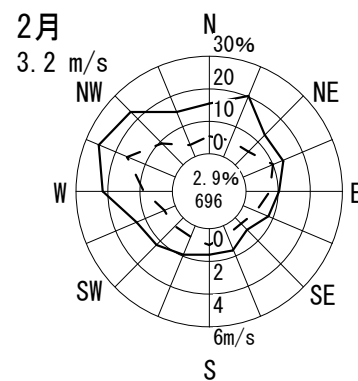
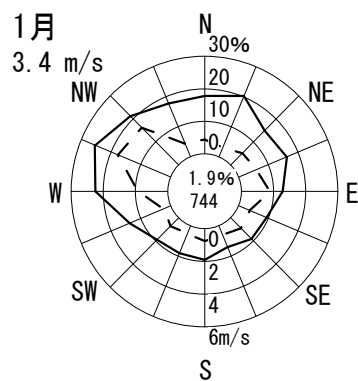
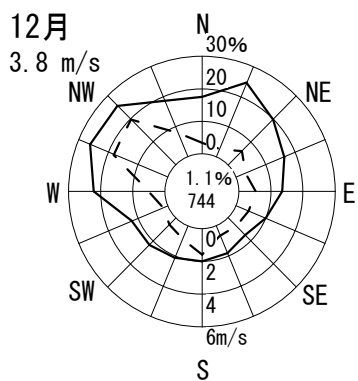
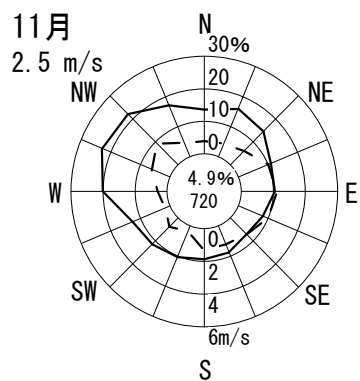
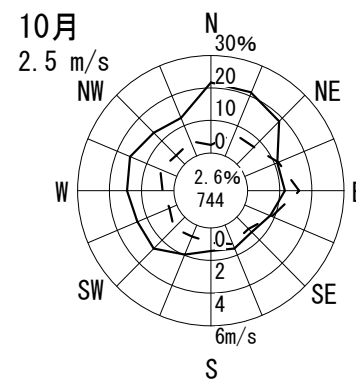
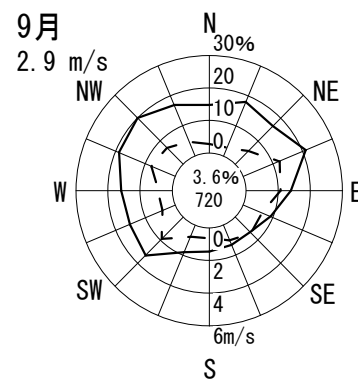
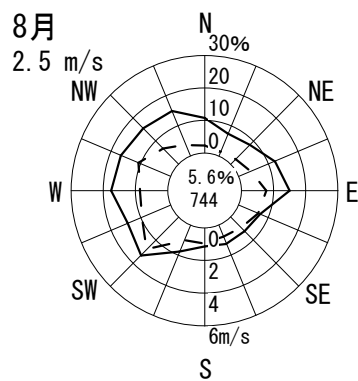
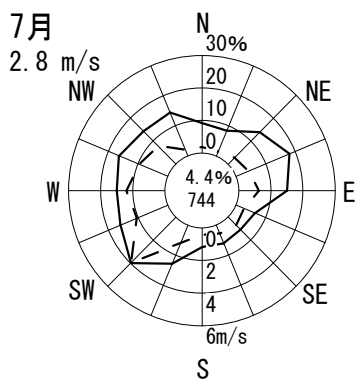
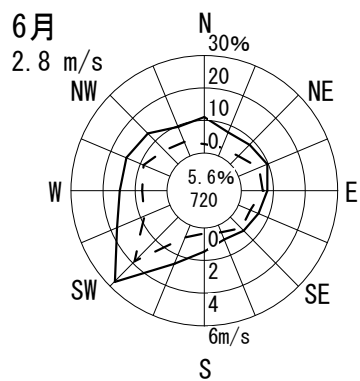
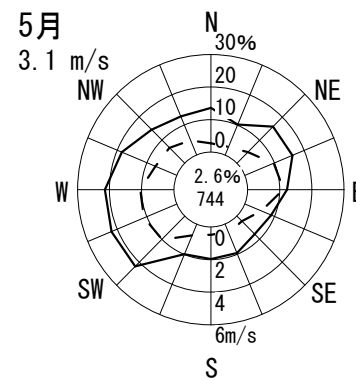
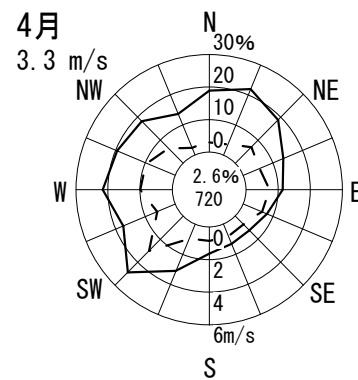
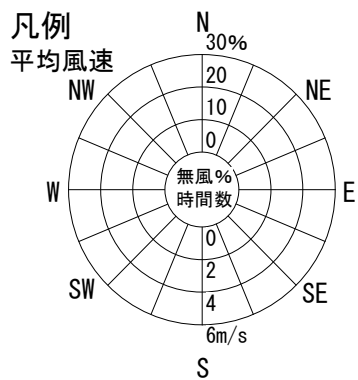
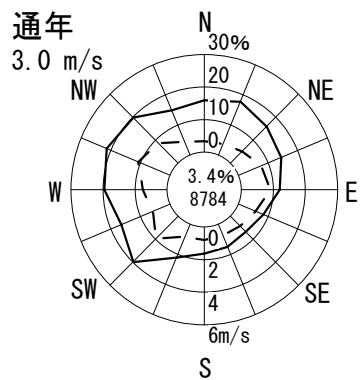

# 風配図 - 月別

測定局：守口保健所

2011年4月～2012年3月 1～24 時

風向風速計高さ 15.0 m

--- 出現頻度

— 平均風速

円内 無風%  
測定時間数

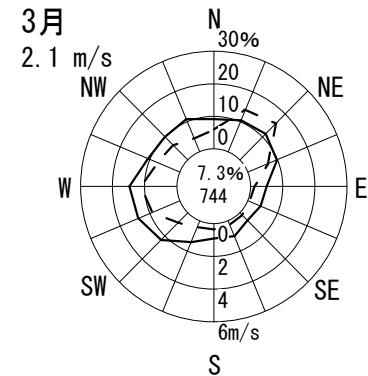
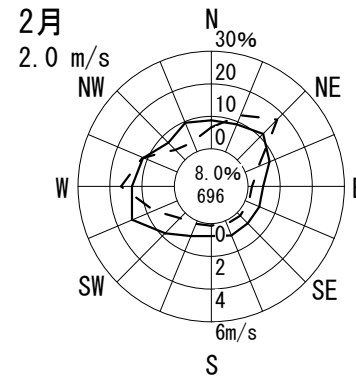
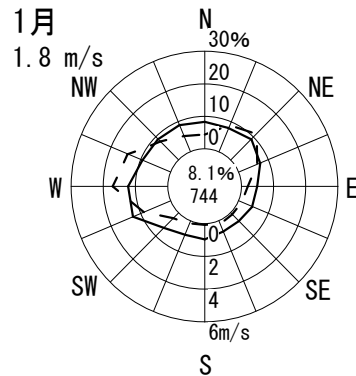
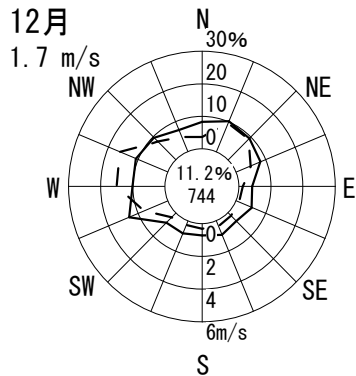
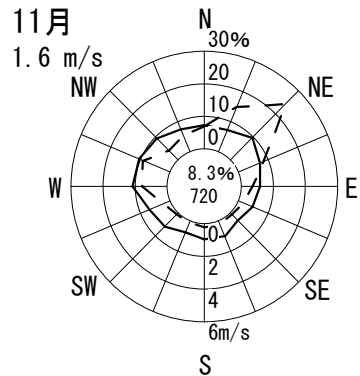
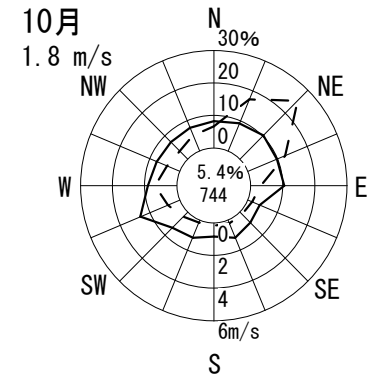
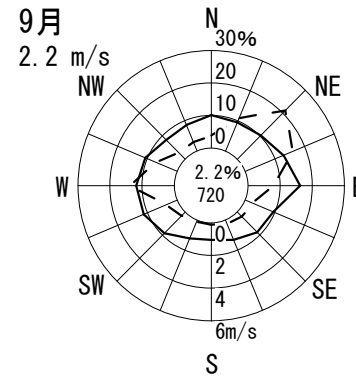
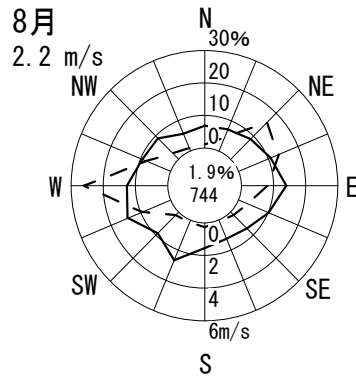
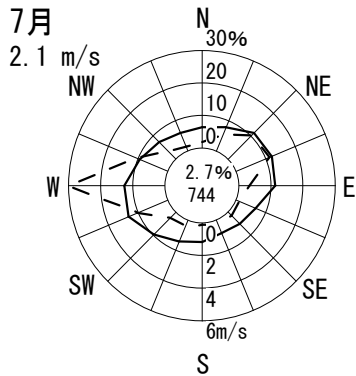
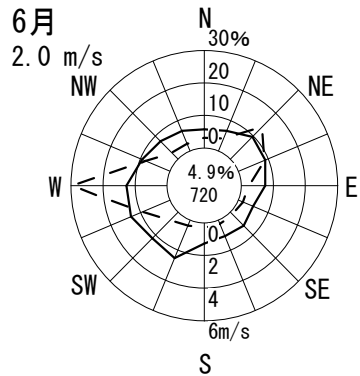
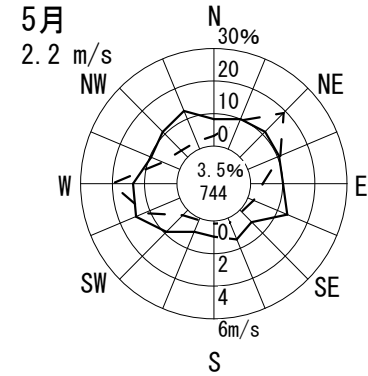
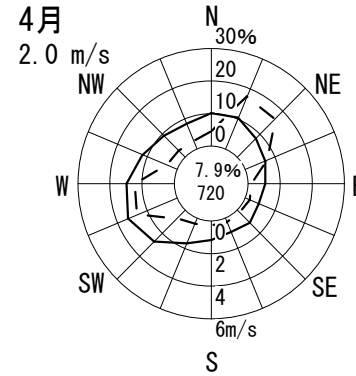
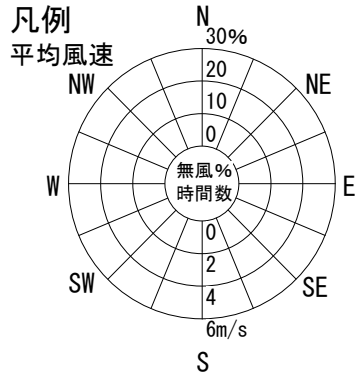
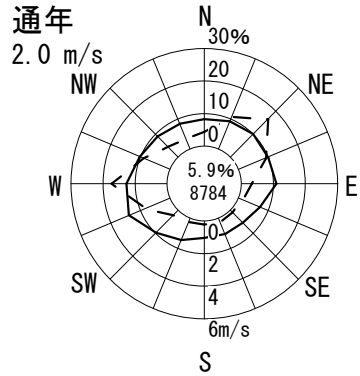



# 風配図 - 月別

測定局：第二測定局（大日）

2011年4月～2012年3月 1～24 時

風向風速計高さ 13.5 m

--- 出現頻度

— 平均風速

円内 無風%  
測定時間数

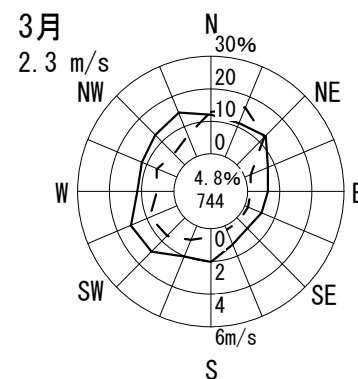
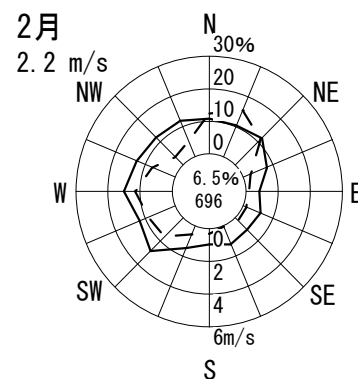
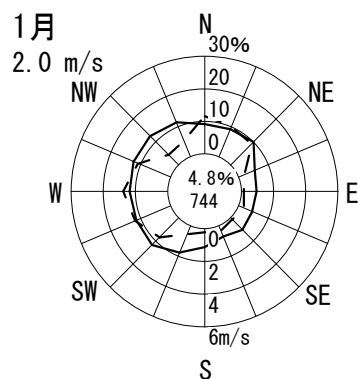
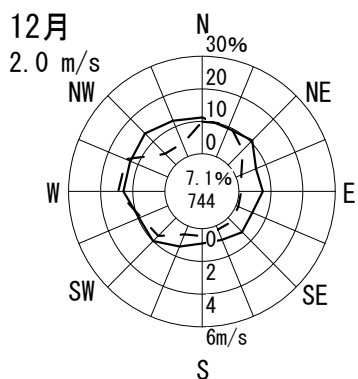
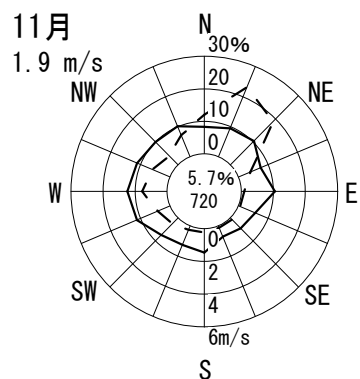
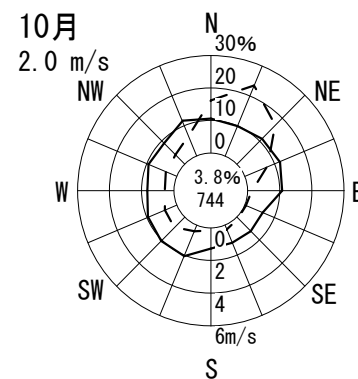
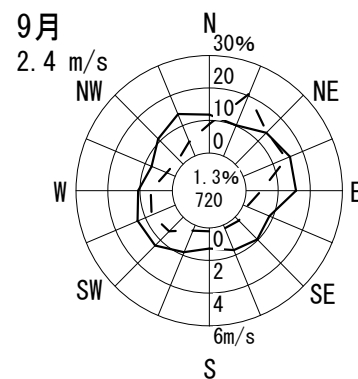
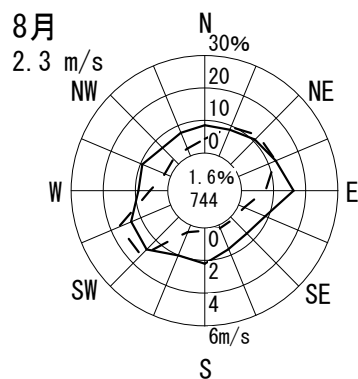
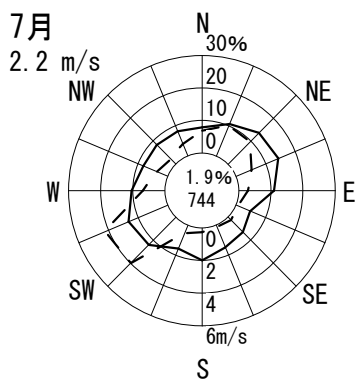
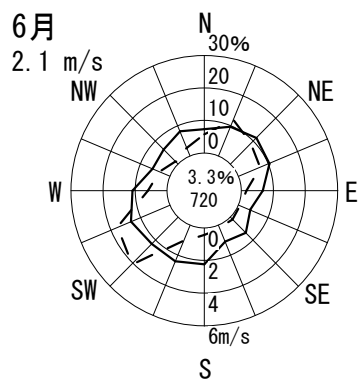
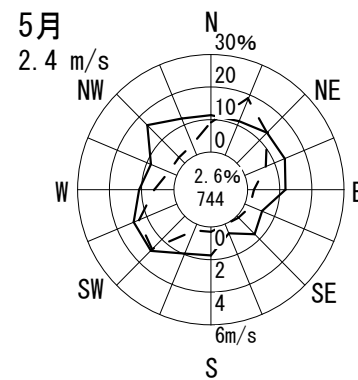
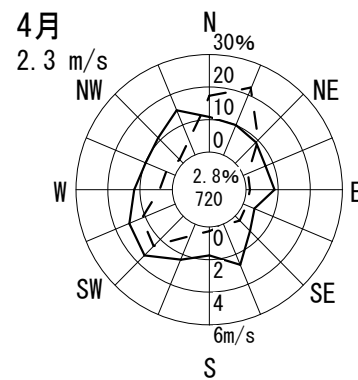
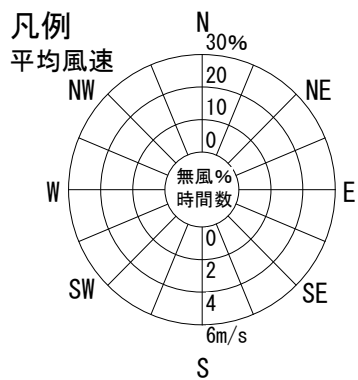
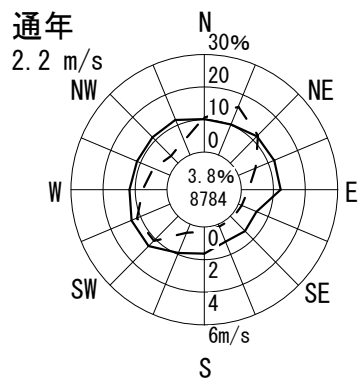

# 風配図 - 月別

測定局：第三測定局（錦）

2011年4月～2012年3月 1～24 時

風向風速計高さ 11.7 m

--- 出現頻度  
—— 平均風速

円内 無風%  
測定時間数

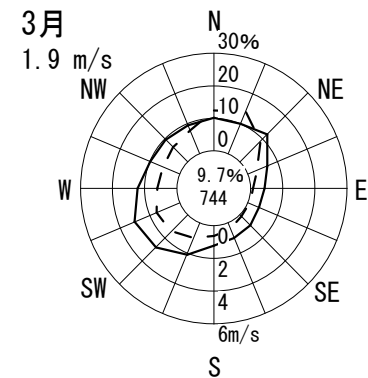
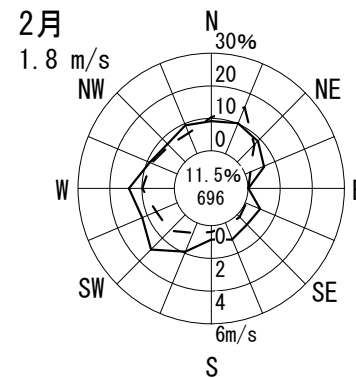
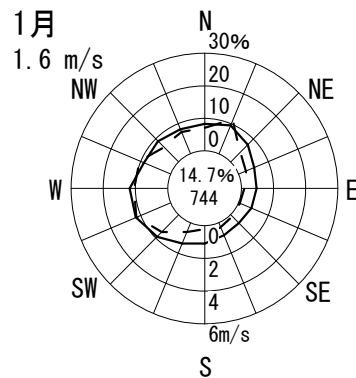
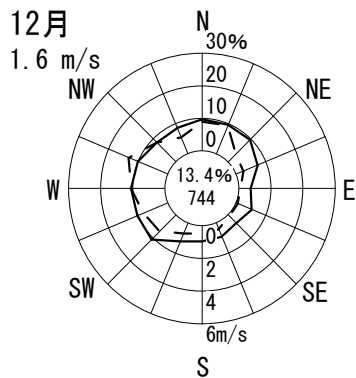
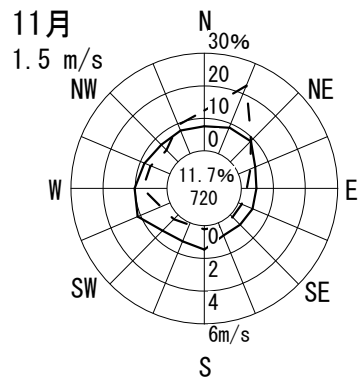
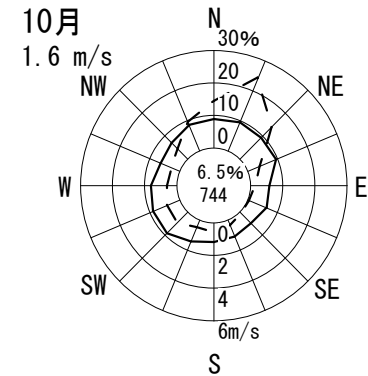
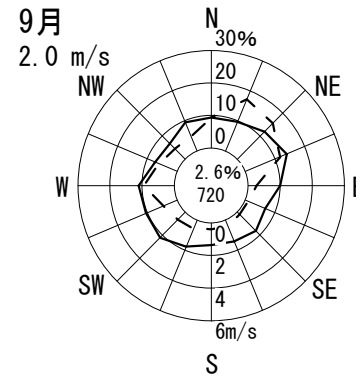
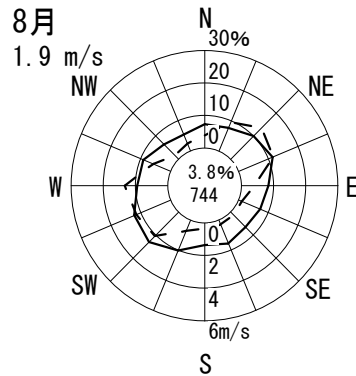
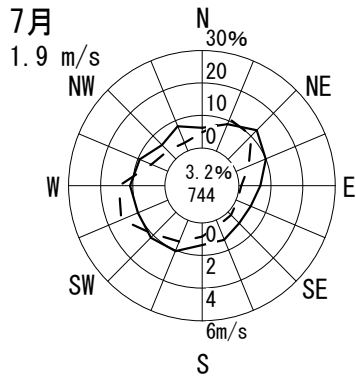
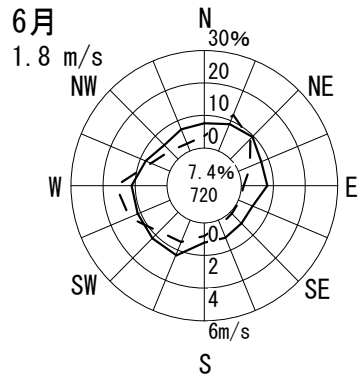
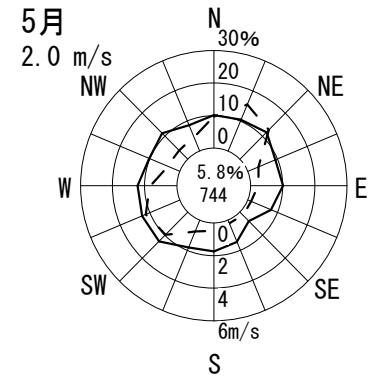
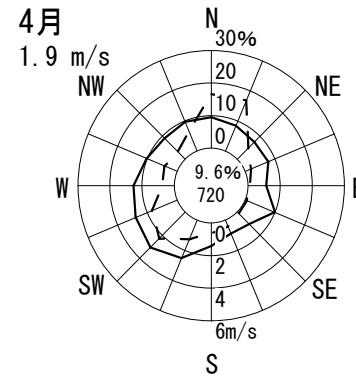
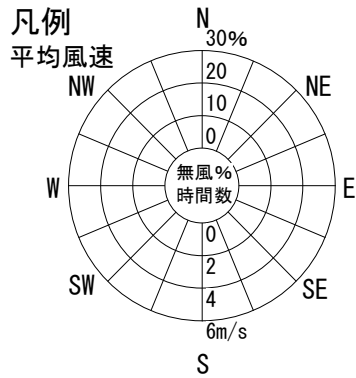
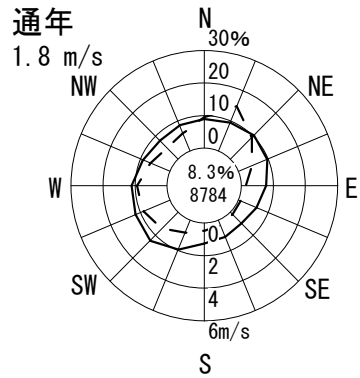

# 風配図 - 月別

測定局：楠葉

2011年4月～2012年3月 1～24 時

風向風速計高さ 13.0 m

--- 出現頻度

— 平均風速

○内 無風%  
測定時間数

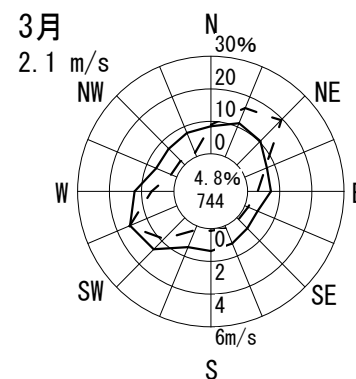
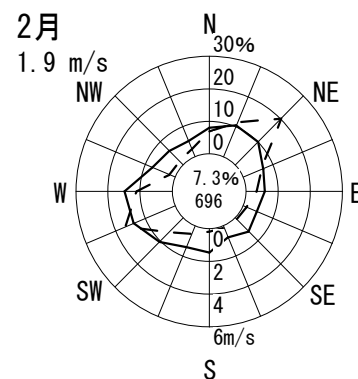
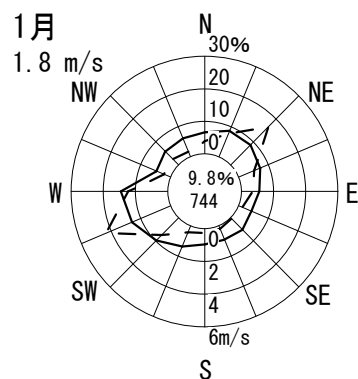
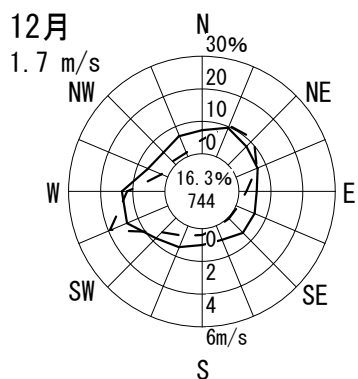
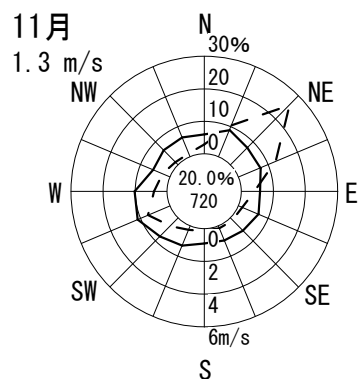
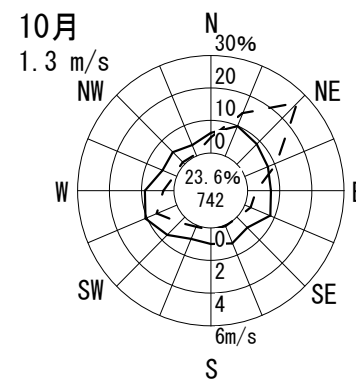
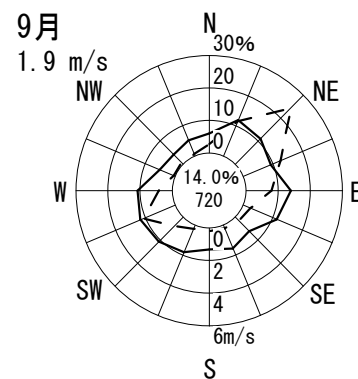
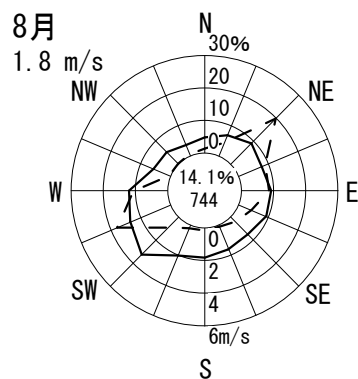
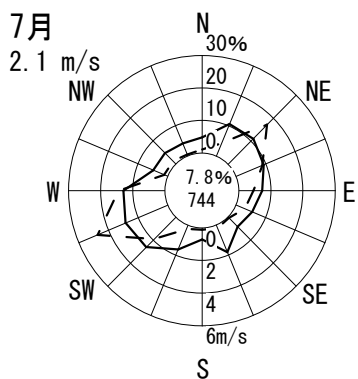
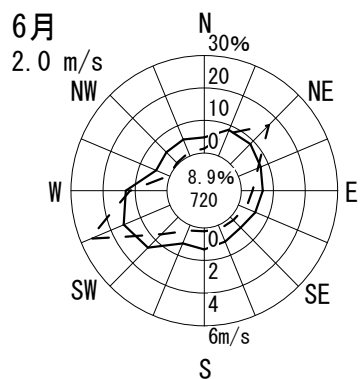
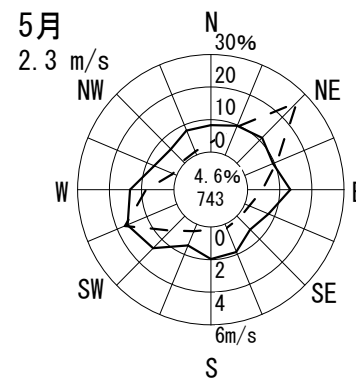
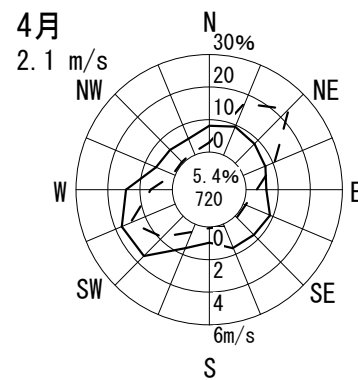
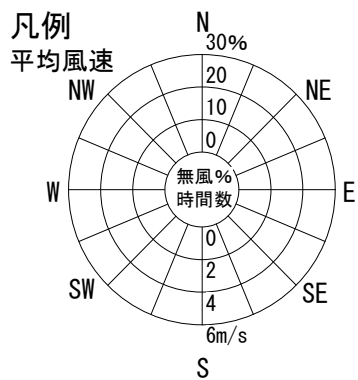
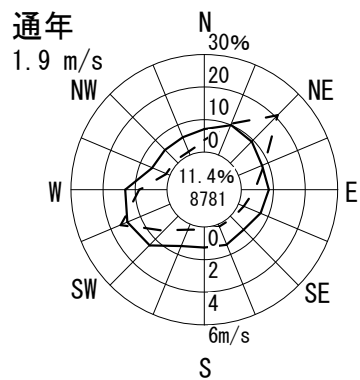

# 風配図 - 月別

測定局：枚方市役所

2011年4月～2012年3月 1～24 時  
風向風速計高さ 28.0 m

--- 出現頻度  
—— 平均風速

円内 無風%  
測定時間数

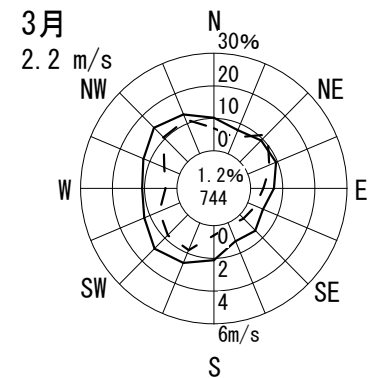
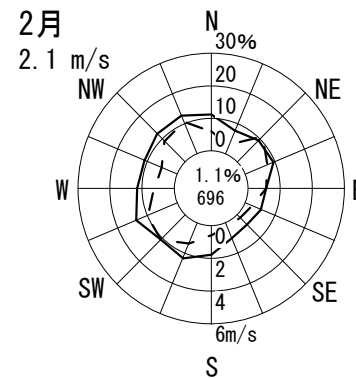
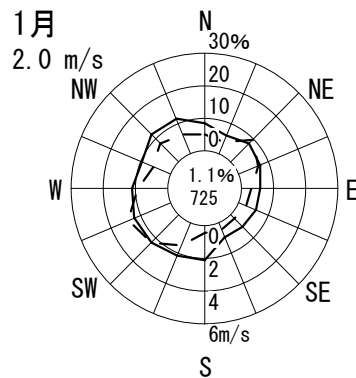
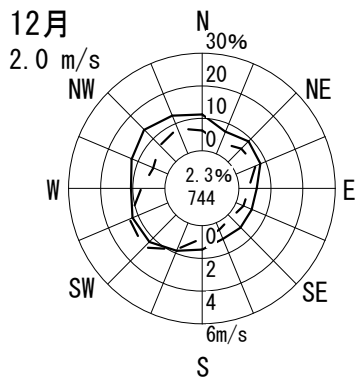
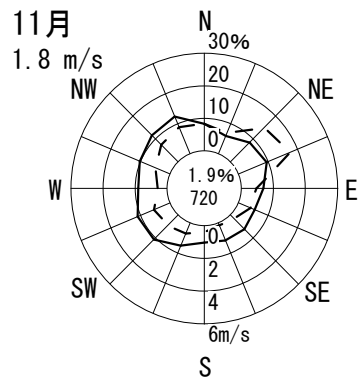
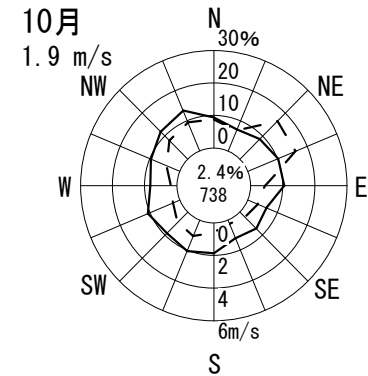
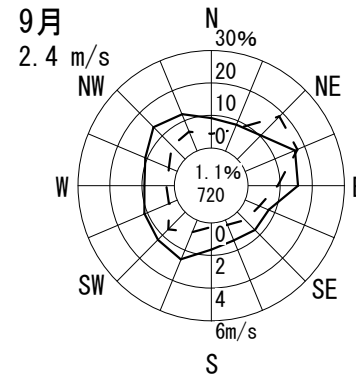
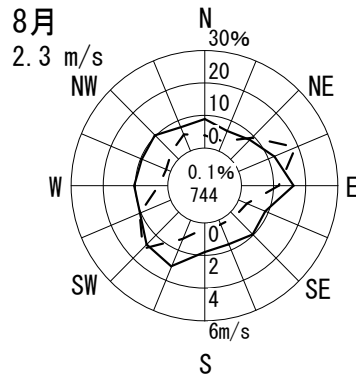
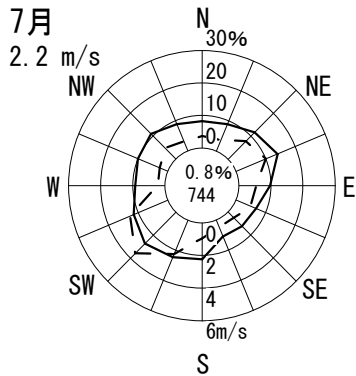
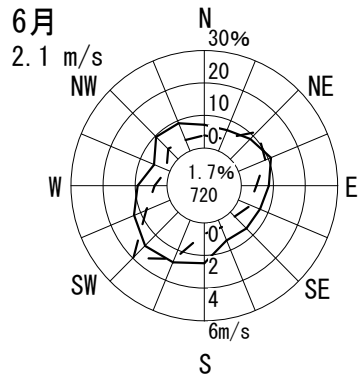
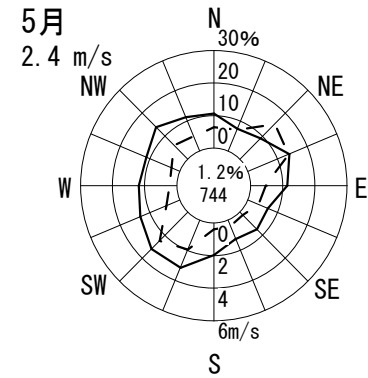
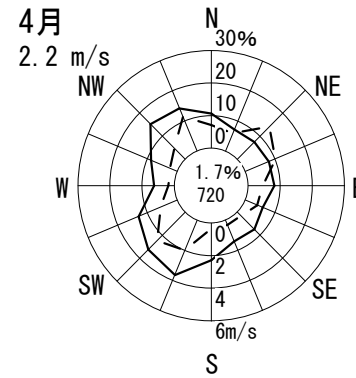
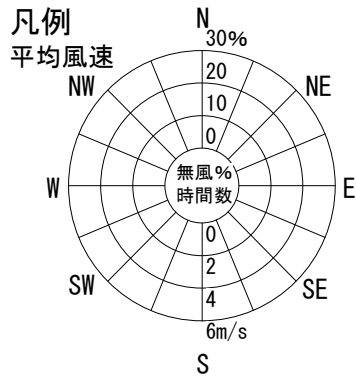
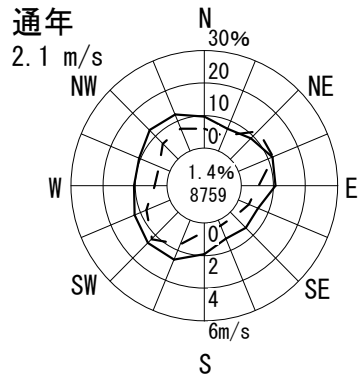

# 風配図 - 月別

測定局：王仁公園

2011年4月～2012年3月 1～24 時

風向風速計高さ 8.0 m

--- 出現頻度

— 平均風速

円内 無風%  
測定時間数

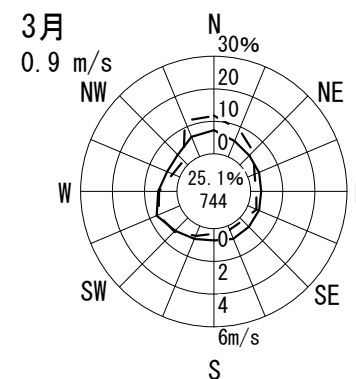
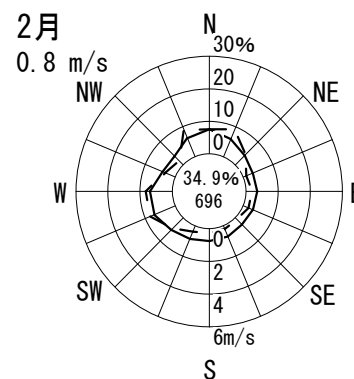
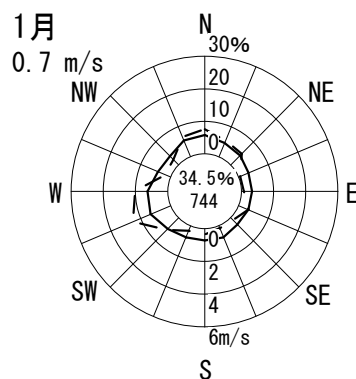
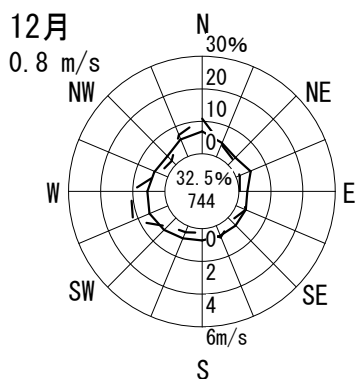
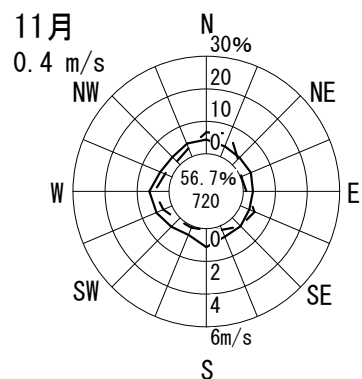
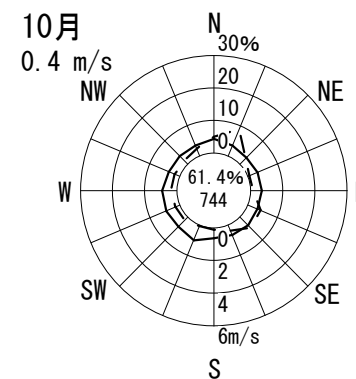
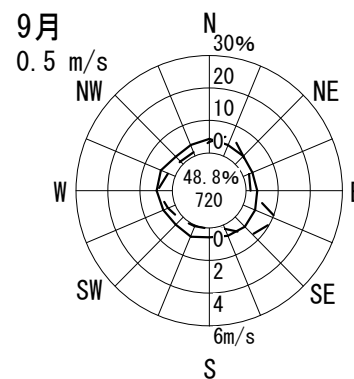
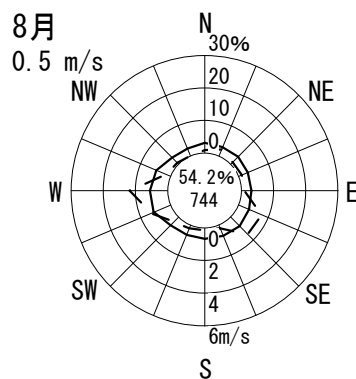
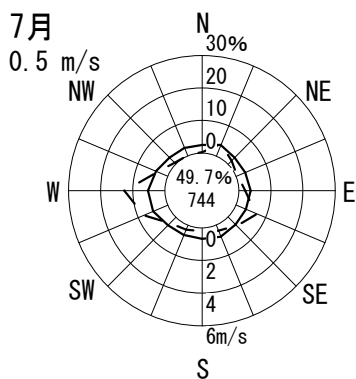
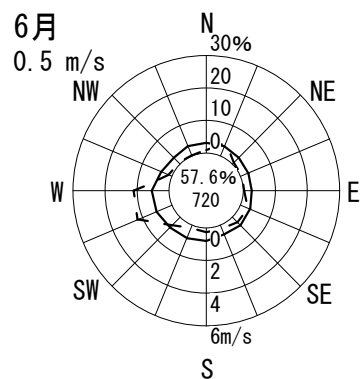
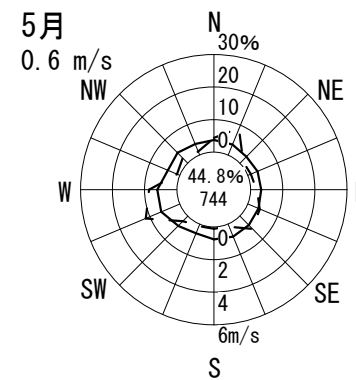
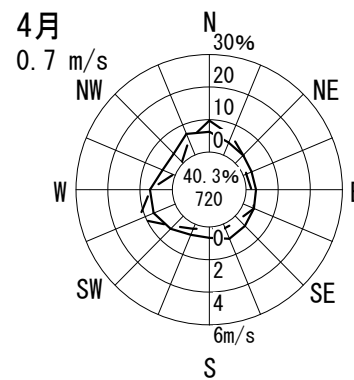
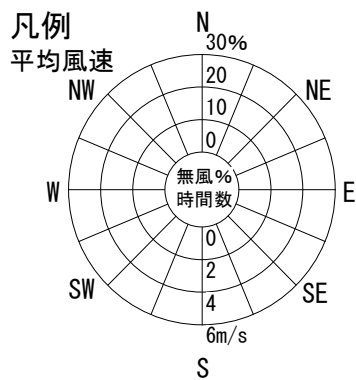
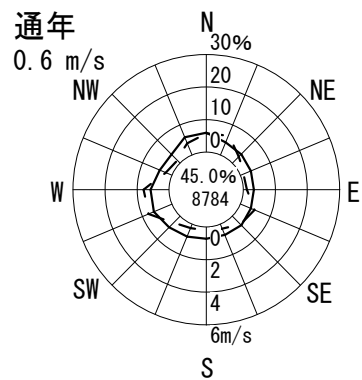

# 風配図 - 月別

測定局：茨木市役所

2011年4月～2012年3月 1～24 時

風向風速計高さ 43.6 m

--- 出現頻度  
—— 平均風速

円内 無風%  
測定時間数

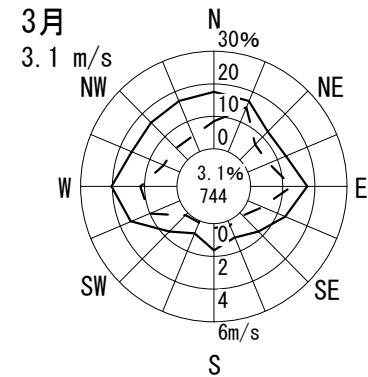
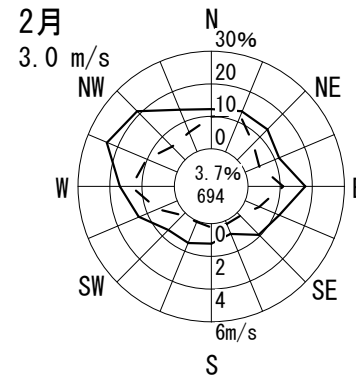
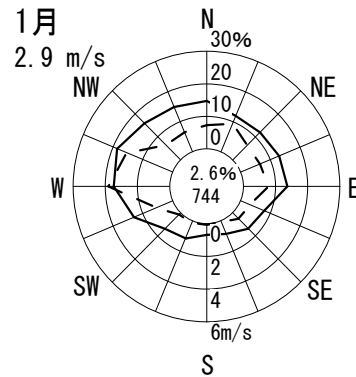
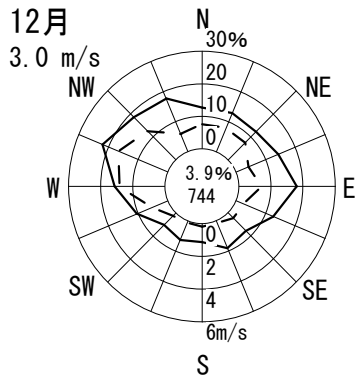
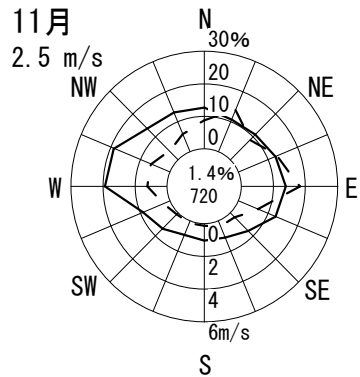
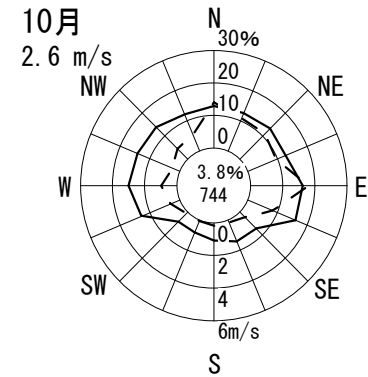
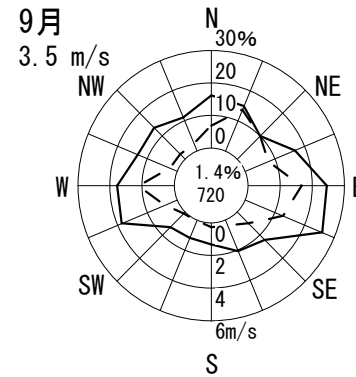
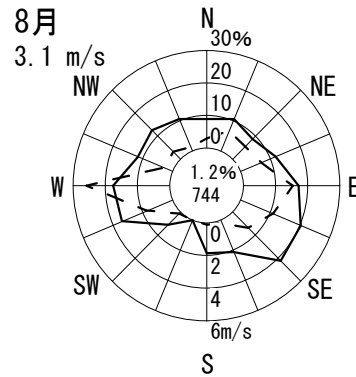
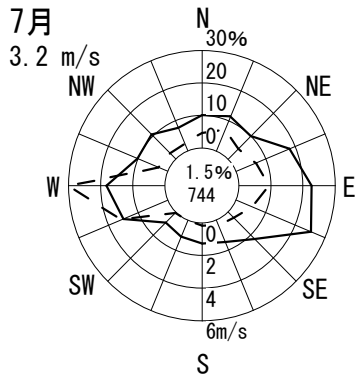
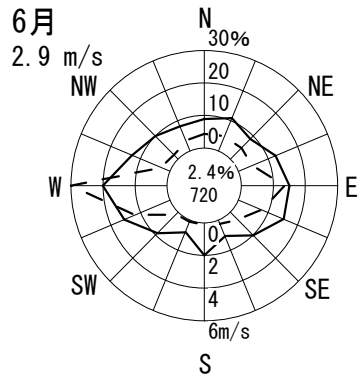
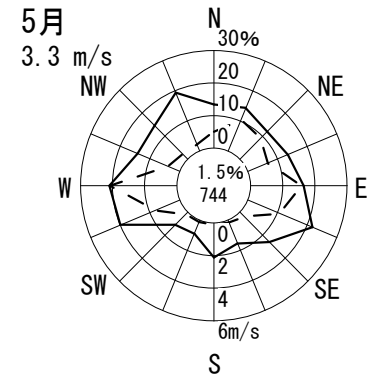
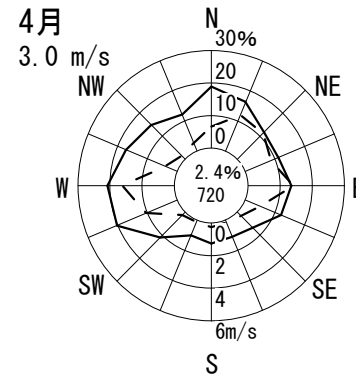
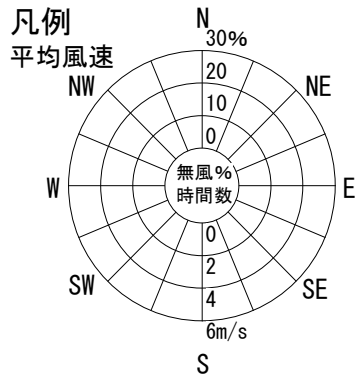
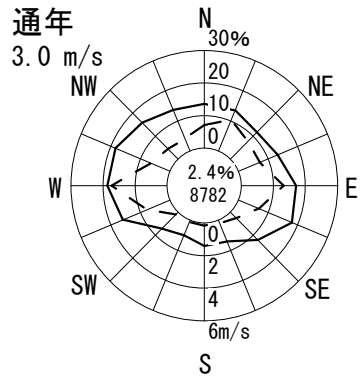

# 風配図 - 月別

測定局：耳原小学校

2011年4月～2012年3月 1～24 時

風向風速計高さ 12.0 m

--- 出現頻度

— 平均風速

円内 無風%  
測定時間数

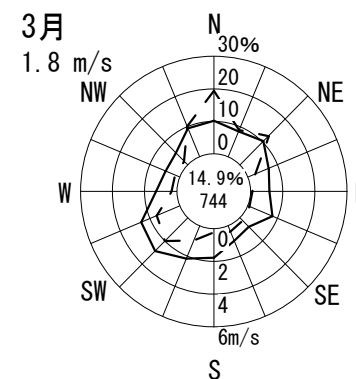
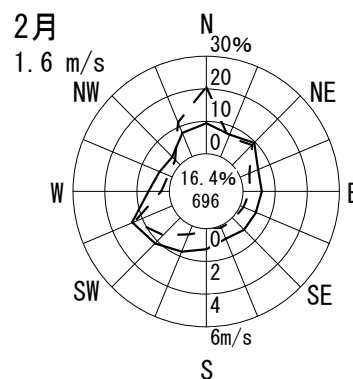
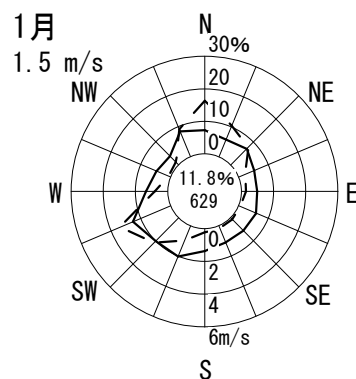
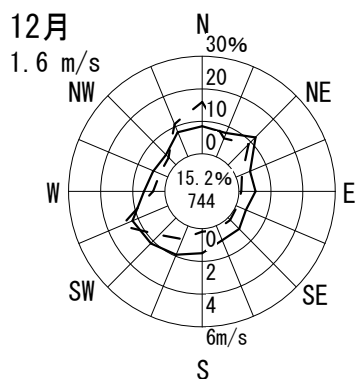
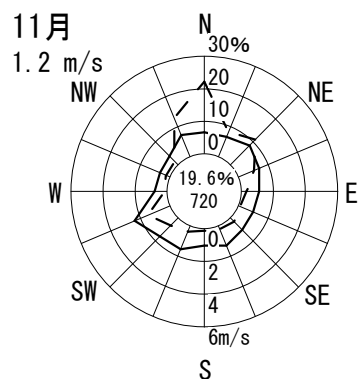
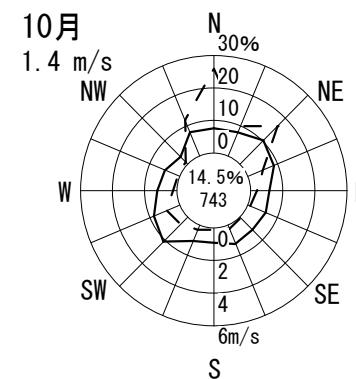
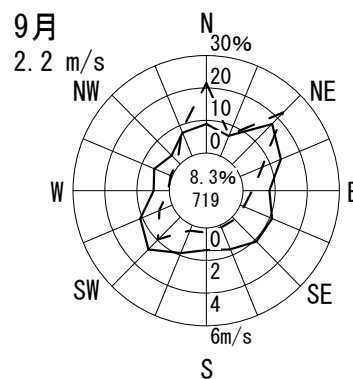
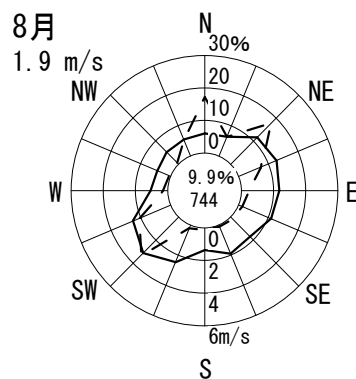
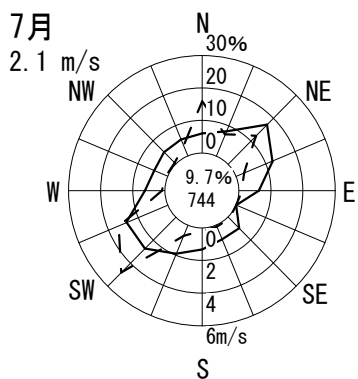
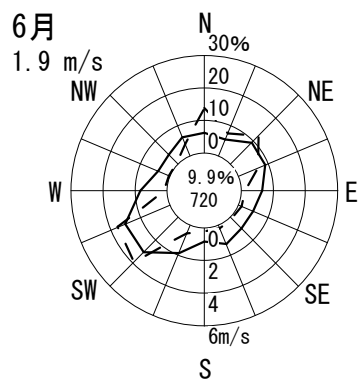
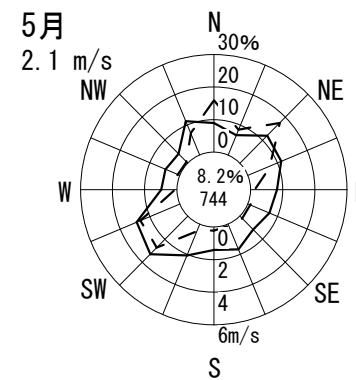
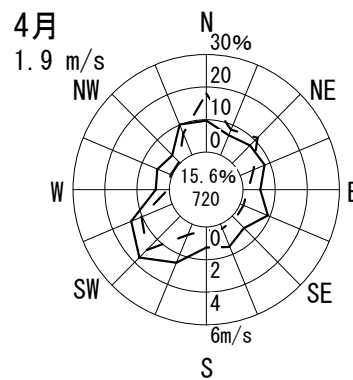
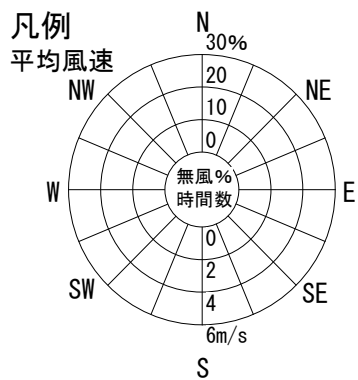
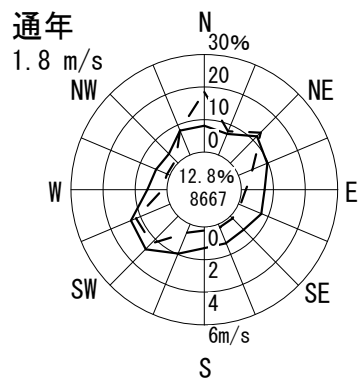

# 風配図 - 月別

測定局：八尾保健所

2011年4月～2012年3月 1～24 時

風向風速計高さ 16.3 m

--- 出現頻度  
—— 平均風速

円内 無風%  
測定時間数

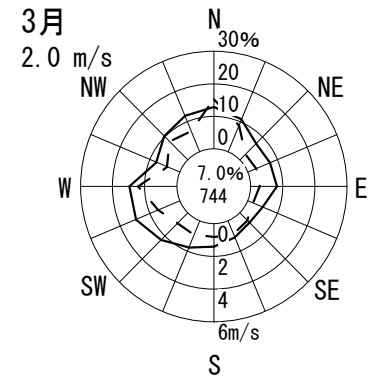
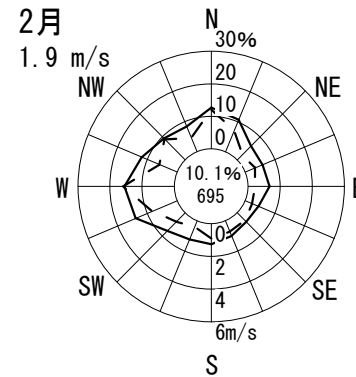
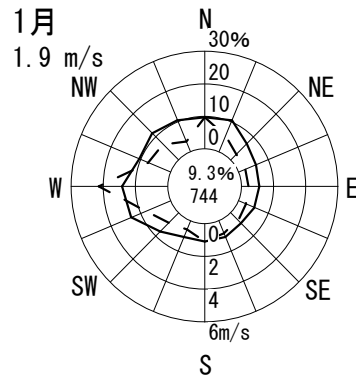
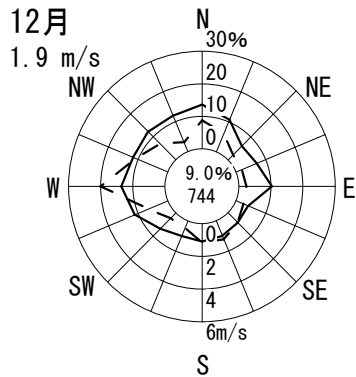
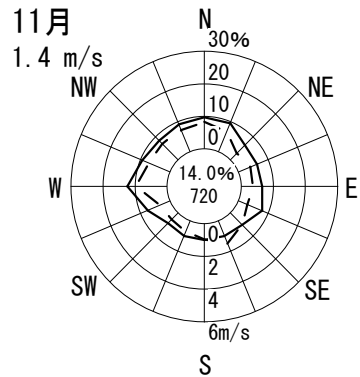
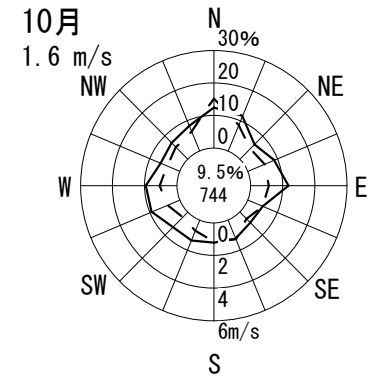
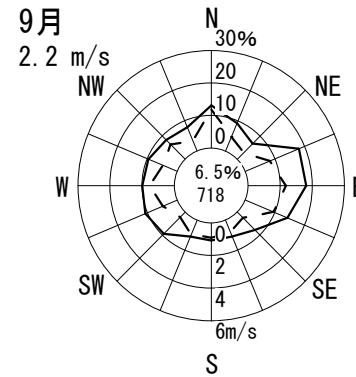
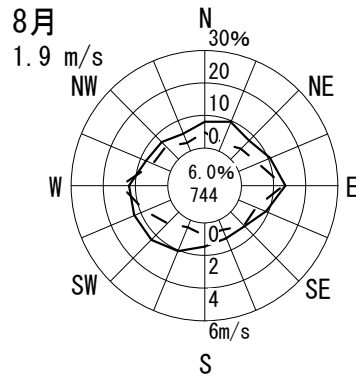
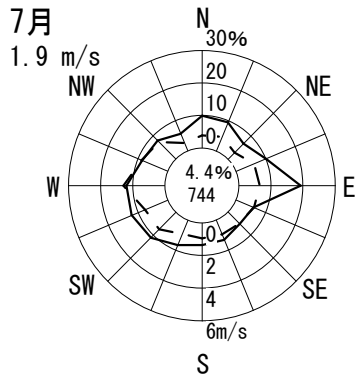
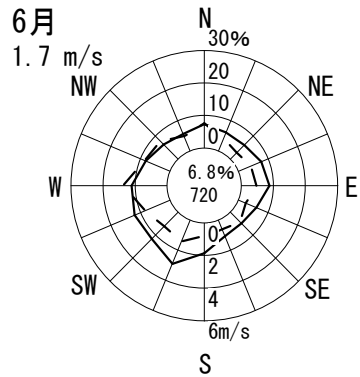
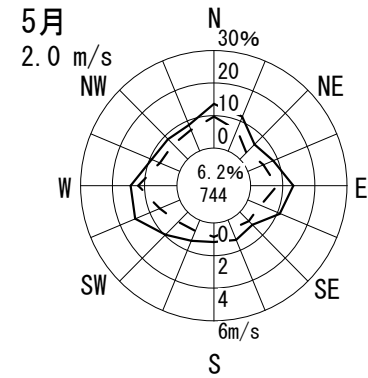
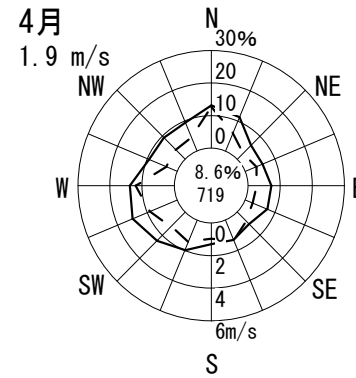
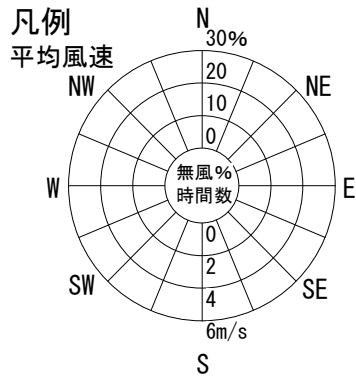
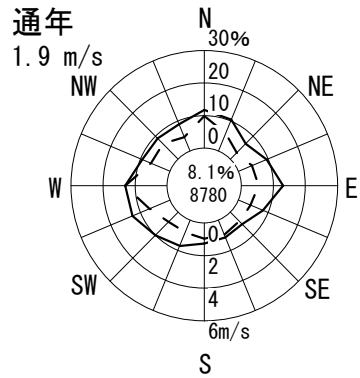



# 風配図 - 月別

測定局：水越

2011年4月～2012年3月 1～24 時

風向風速計高さ 6.0 m

--- 出現頻度

— 平均風速

円内 無風%  
測定時間数

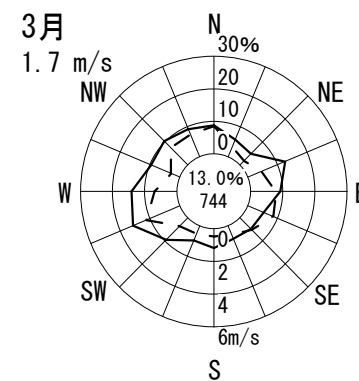
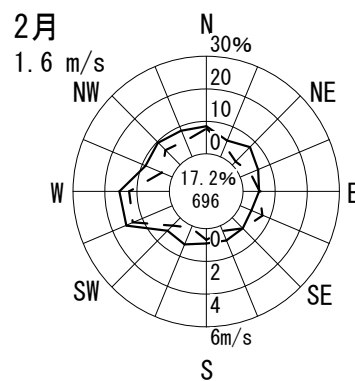
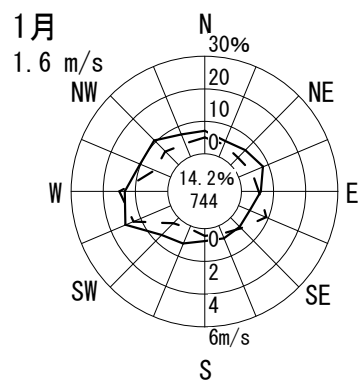
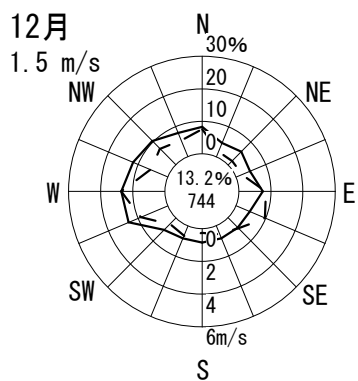
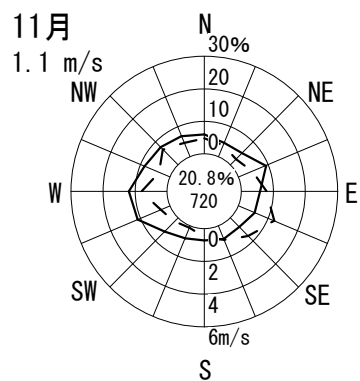
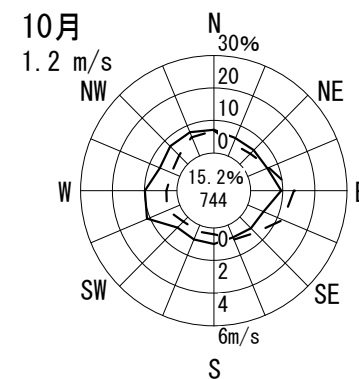
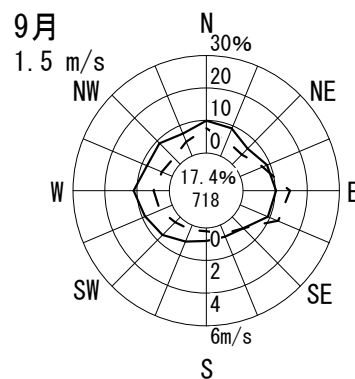
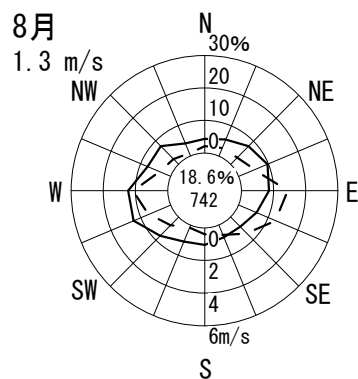
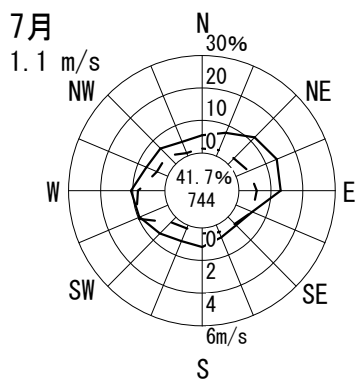
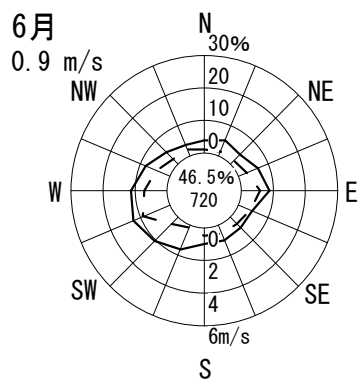
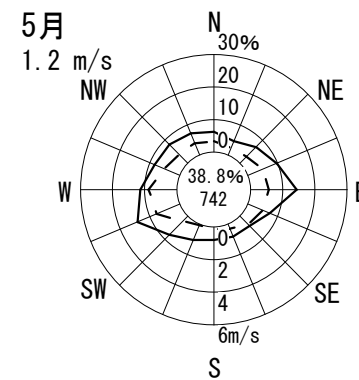
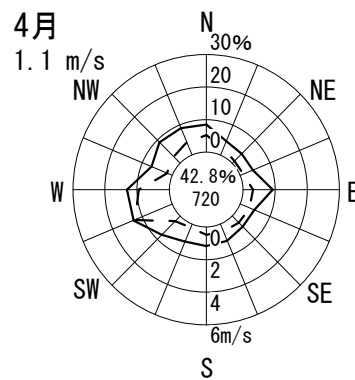
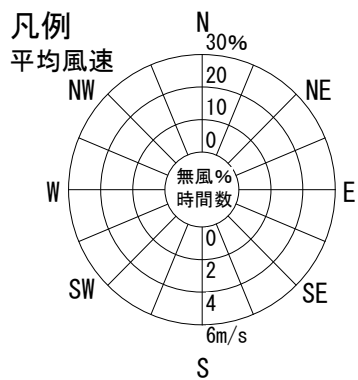
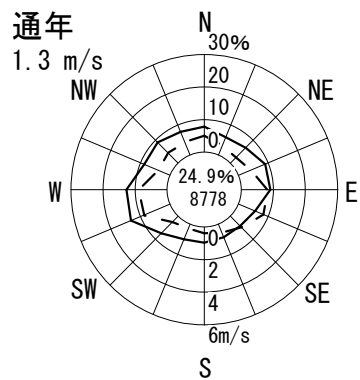

# 風配図 - 月別

測定局：佐野中学校

2011年4月～2012年3月 1～24 時

風向風速計高さ 15.2 m

--- 出現頻度

— 平均風速

○ 無風%

○ 円内

測定時間数

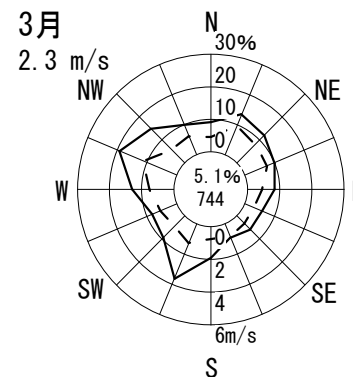
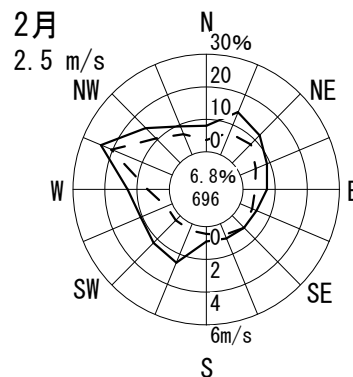
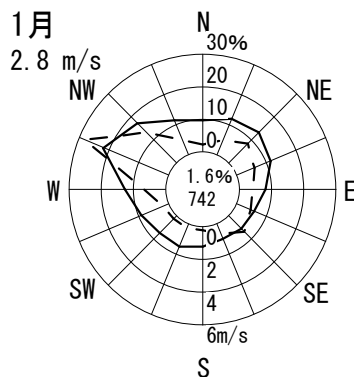
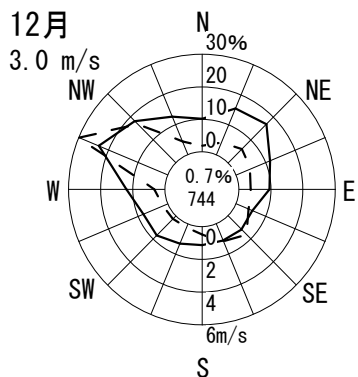
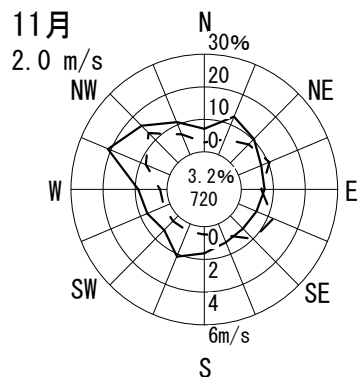
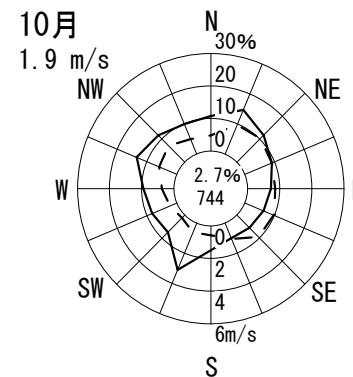
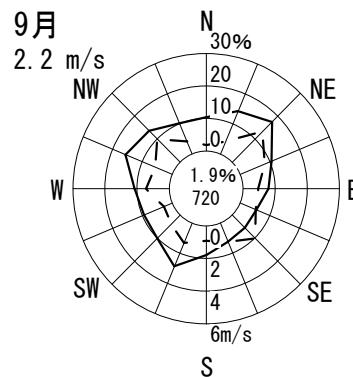
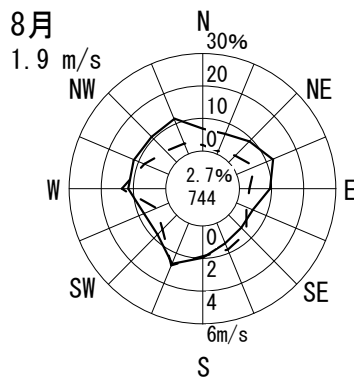
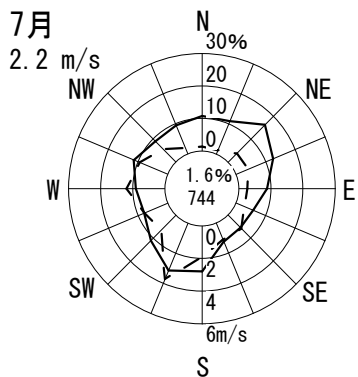
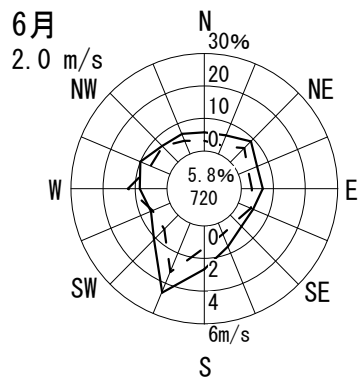
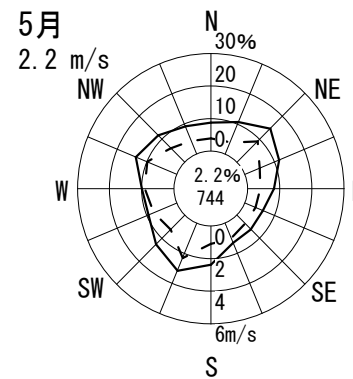
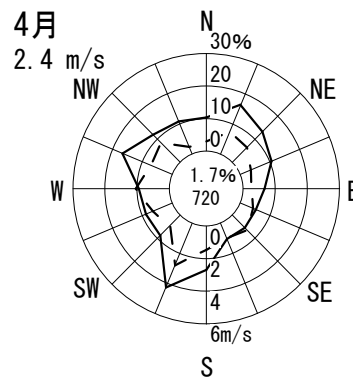
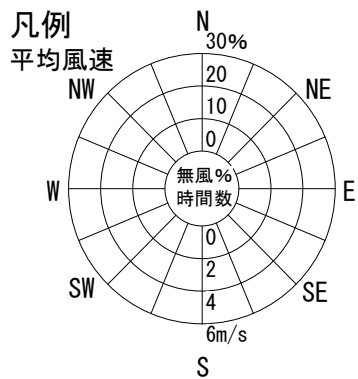
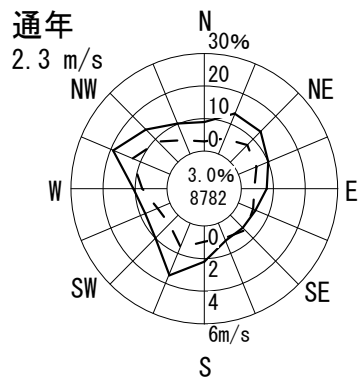

# 風配図 - 月別

測定局：富田林市役所

2011年4月～2012年3月 1～24 時

風向風速計高さ 34.6 m

--- 出現頻度

— 平均風速

円内 無風%  
測定時間数

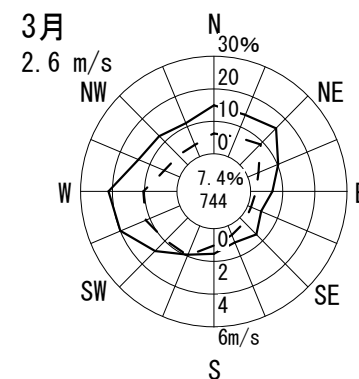
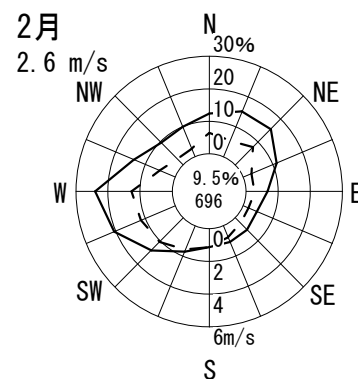
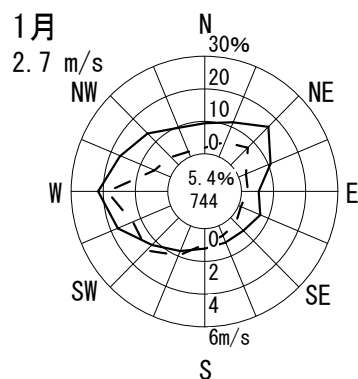
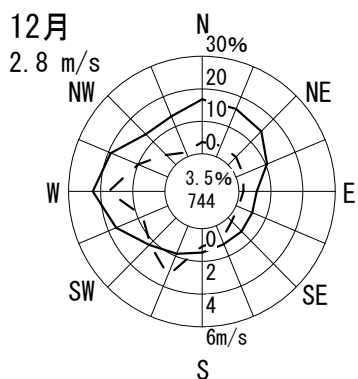
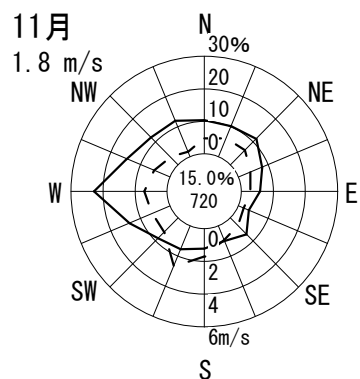
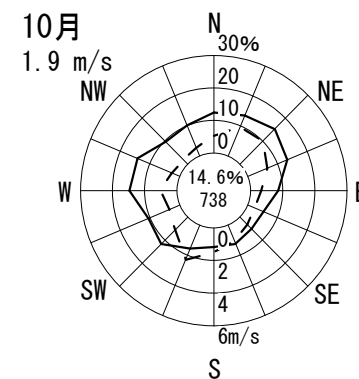
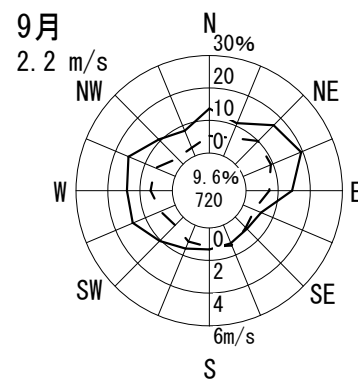
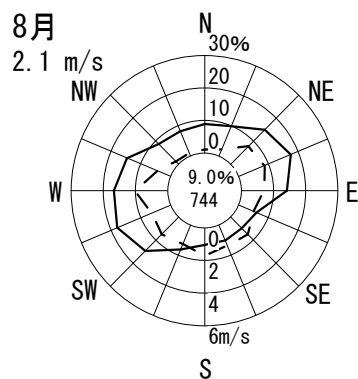
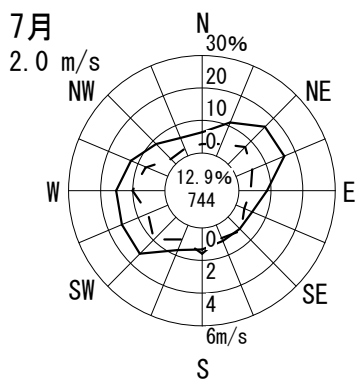
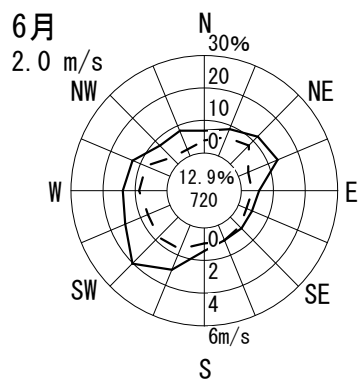
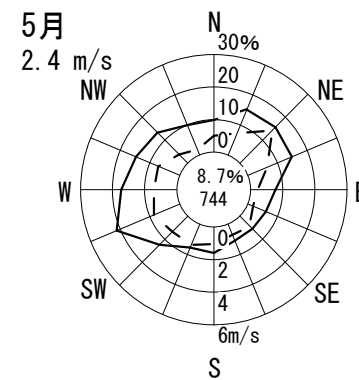
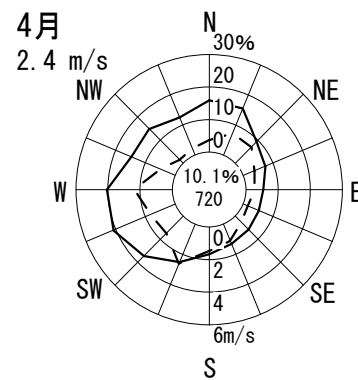
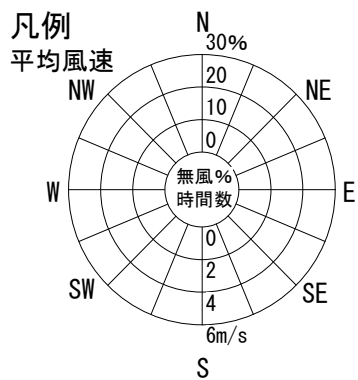
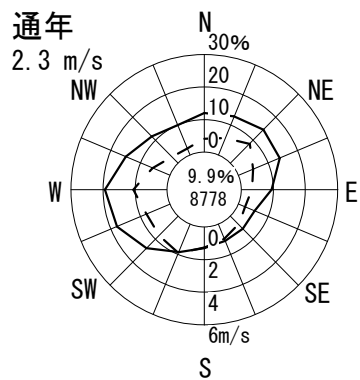

# 風配図 - 月別

測定局：寝屋川市役所

2011年4月～2012年3月 1～24 時

風向風速計高さ 29.0 m

--- 出現頻度  
—— 平均風速

円内 無風%  
測定時間数

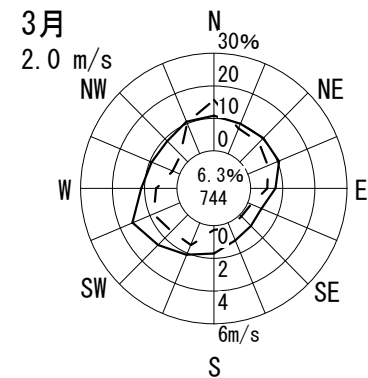
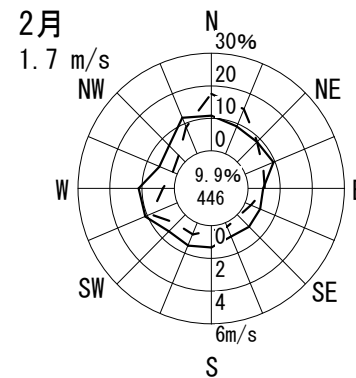
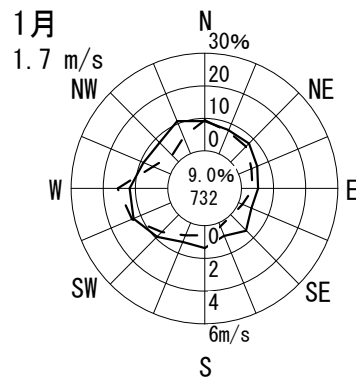
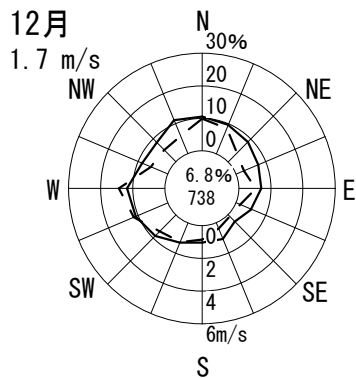
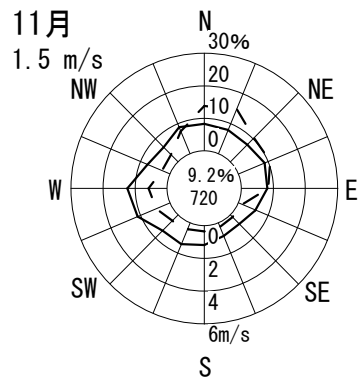
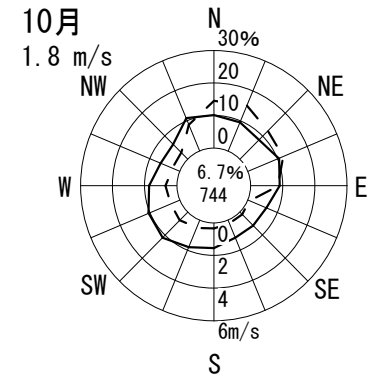
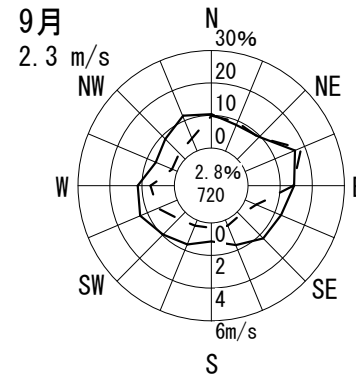
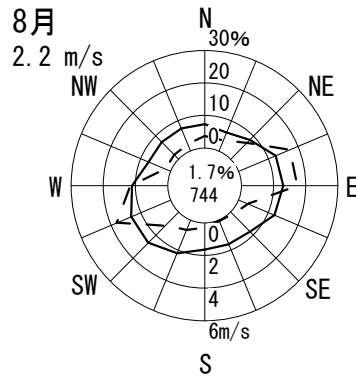
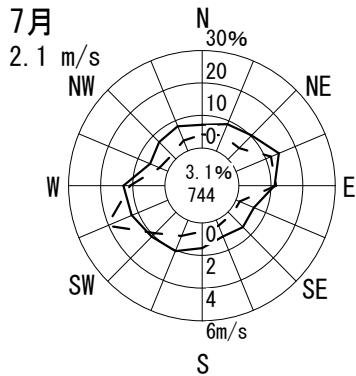
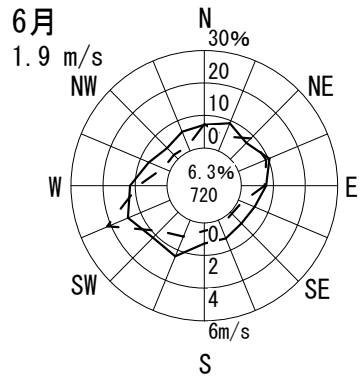
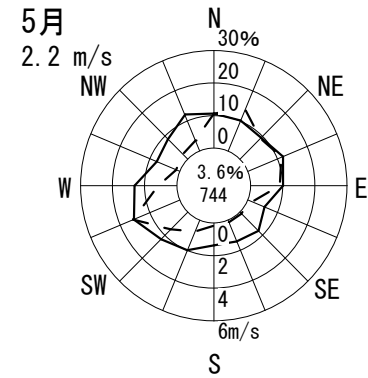
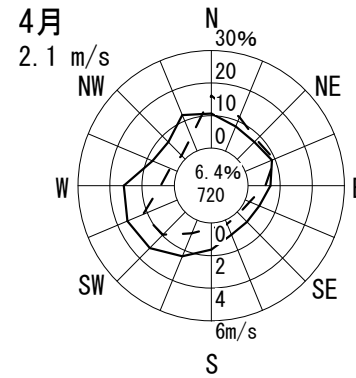
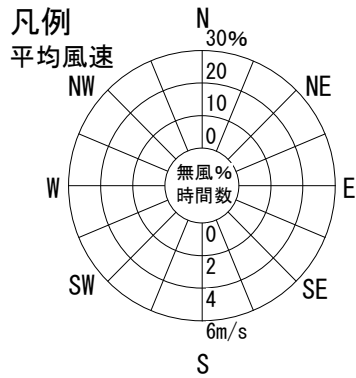
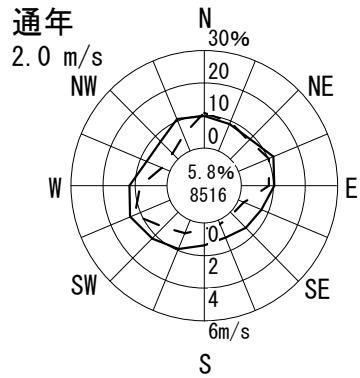

# 風配図 - 月別

測定局：成田

2011年4月～2012年3月 1～24 時  
風向風速計高さ 12.0 m

--- 出現頻度  
—— 平均風速

円内 無風%  
測定時間数

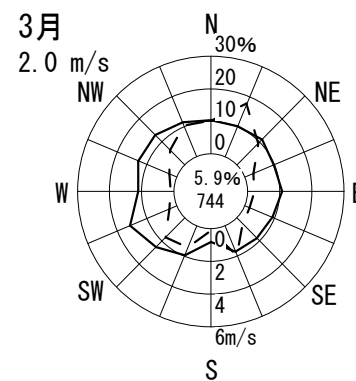
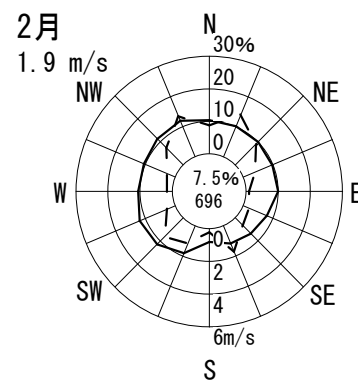
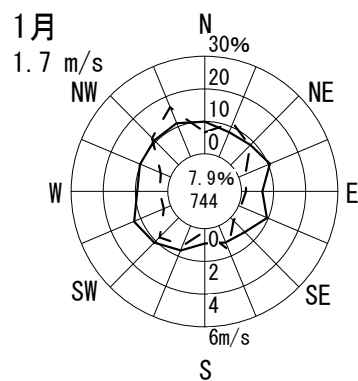
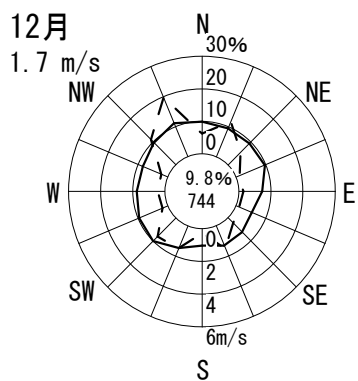
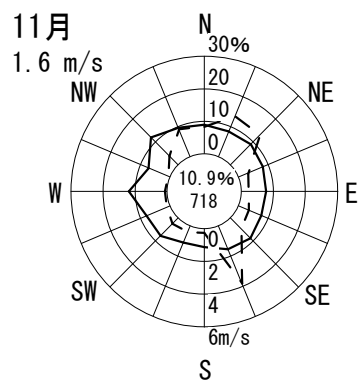
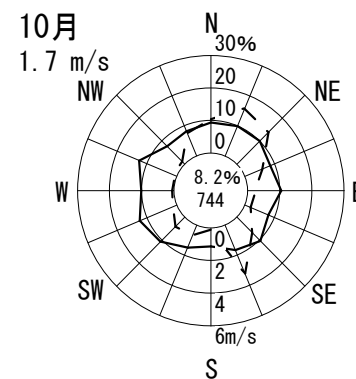
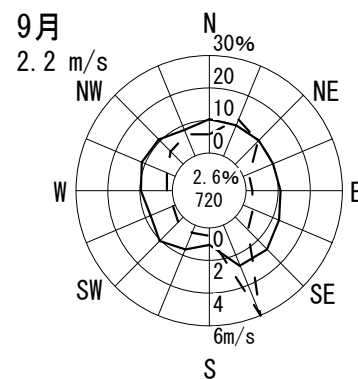
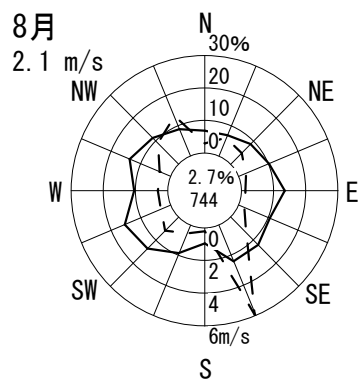
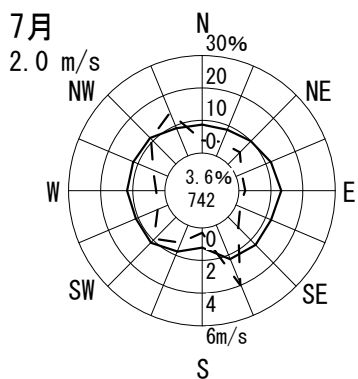
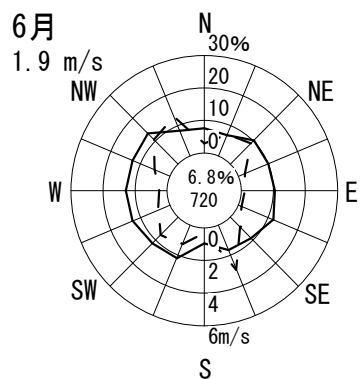
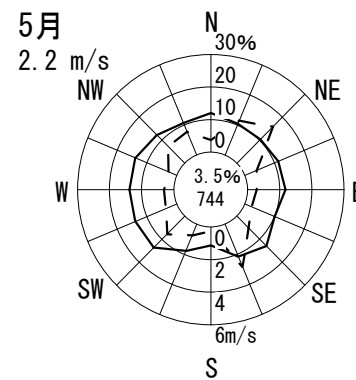
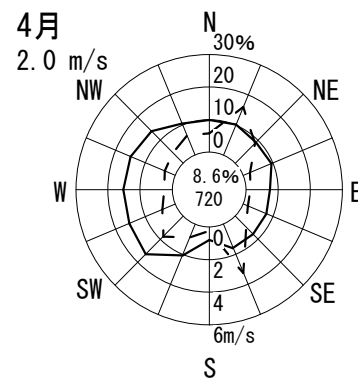
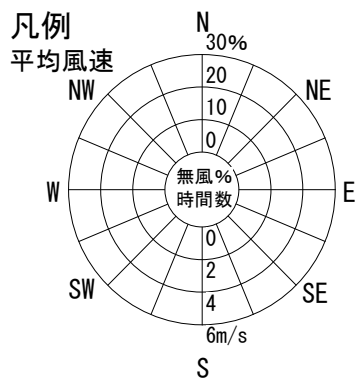
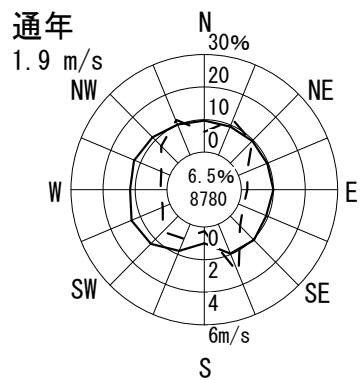

# 風配図 - 月別

測定局：三日市公民館

2011年4月～2012年3月 1～24 時

風向風速計高さ 13.3 m

--- 出現頻度

—— 平均風速

円内 無風%  
測定時間数

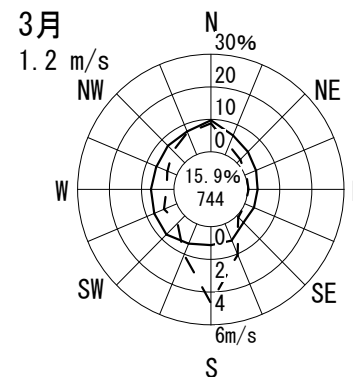
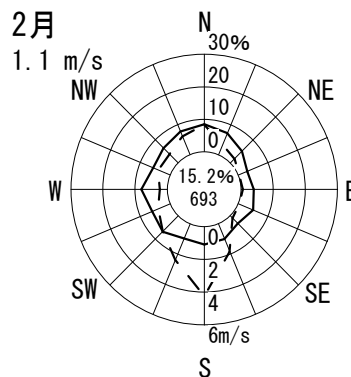
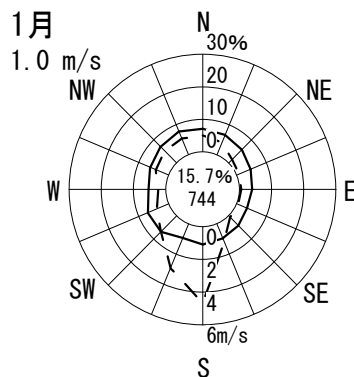
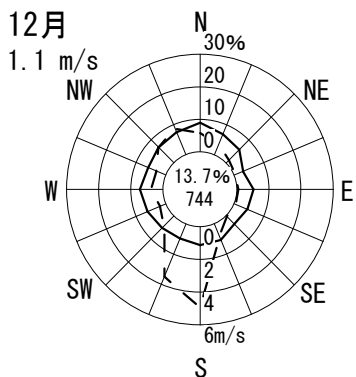
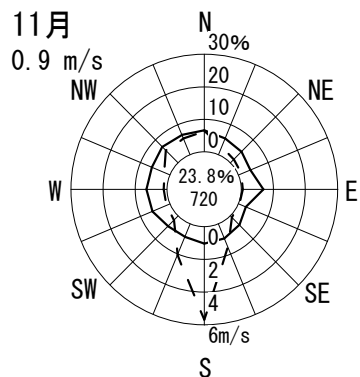
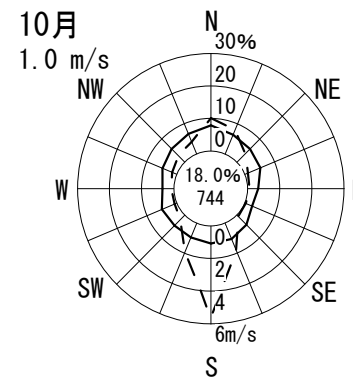
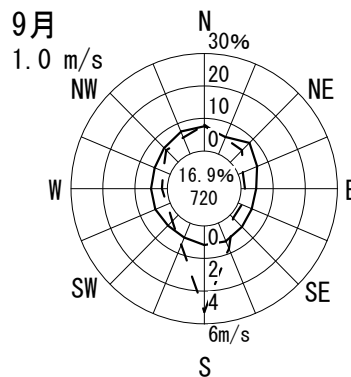
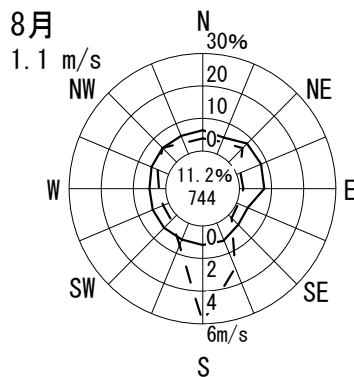
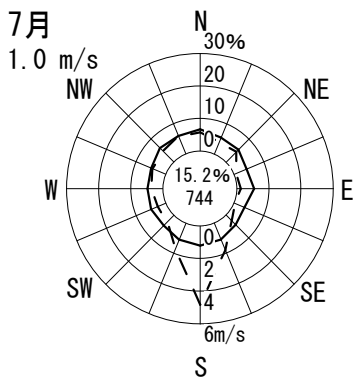
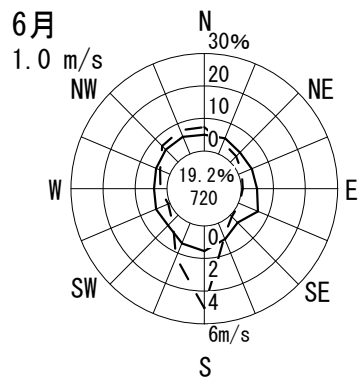
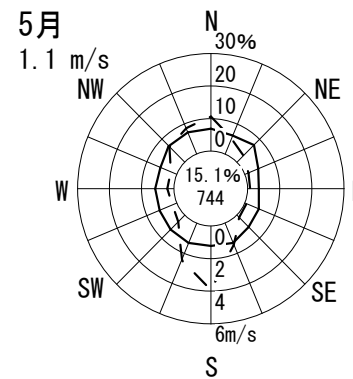
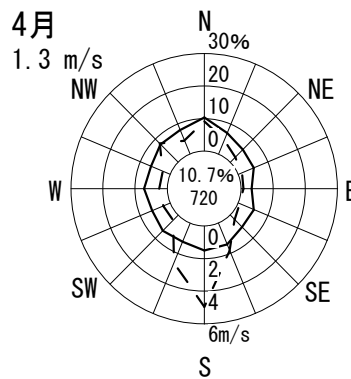
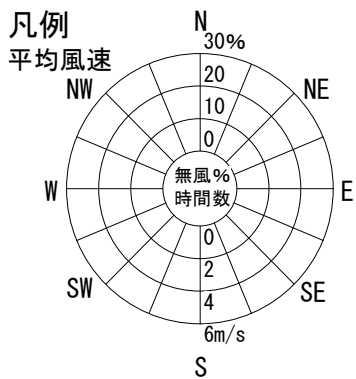
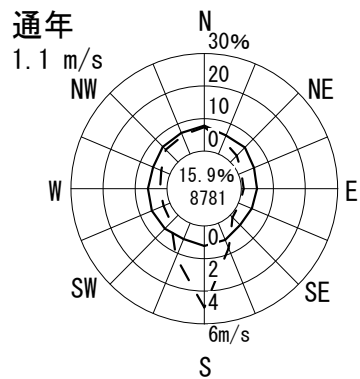

# 風配図 - 月別

測定局：大塚高校

2011年4月～2012年3月 1～24 時

風向風速計高さ 10.0 m

--- 出現頻度

— 平均風速

円内 無風%  
測定時間数

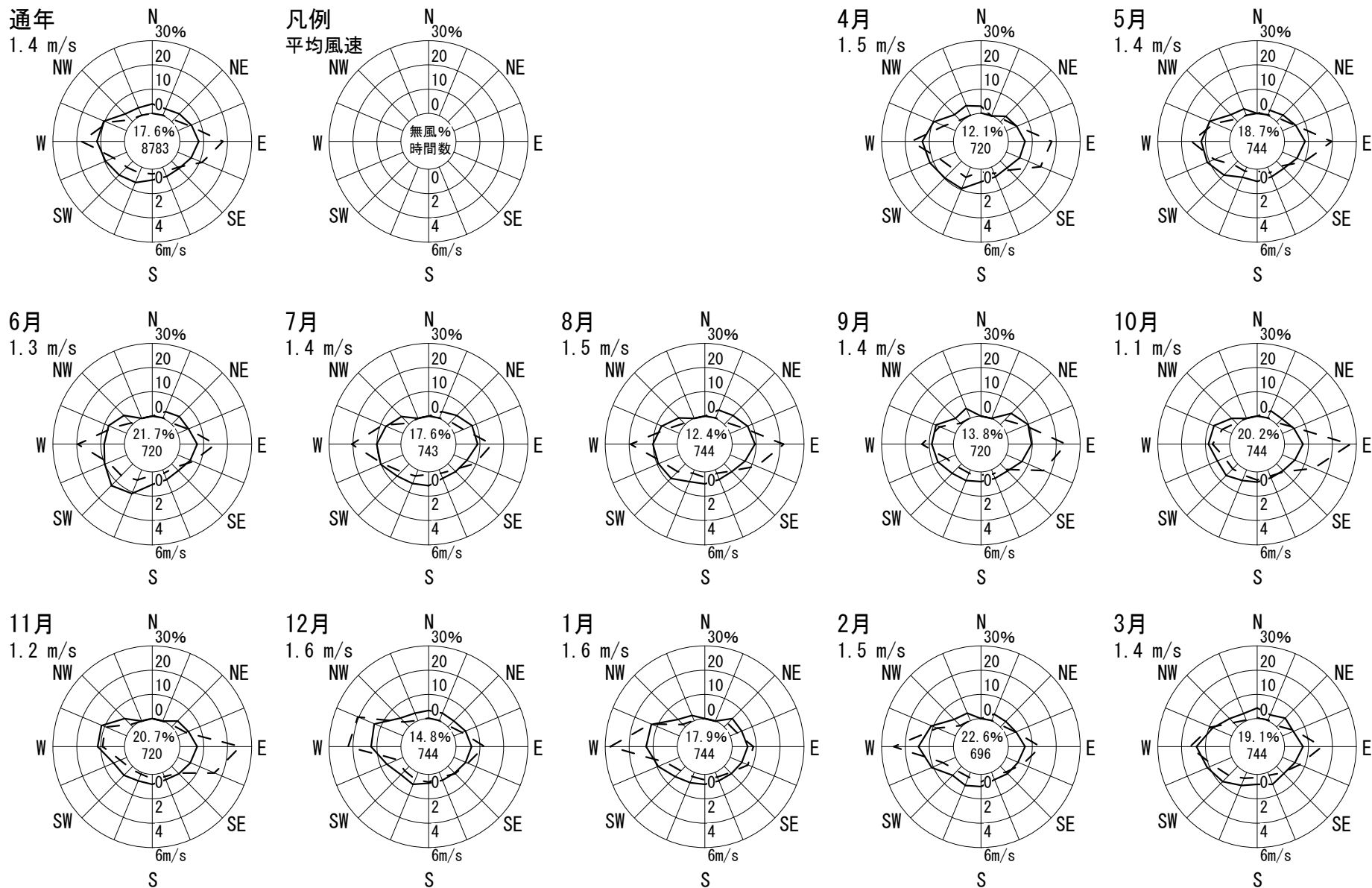

# 風配図 - 月別

測定局：大東市役所

2011年4月～2012年3月 1～24 時

風向風速計高さ 26.9 m

--- 出現頻度

— 平均風速

円内 無風%  
測定時間数

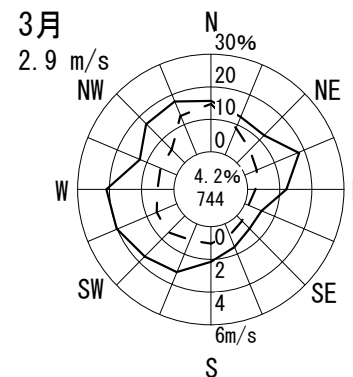
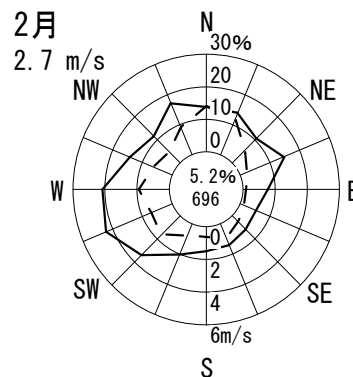
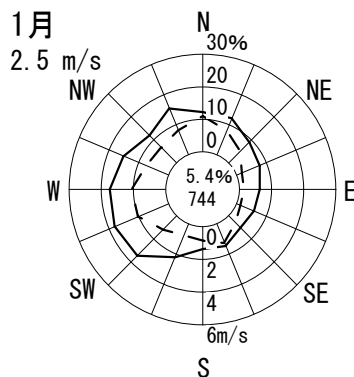
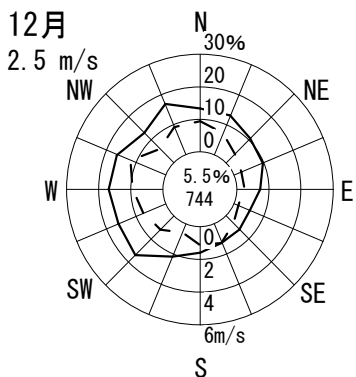
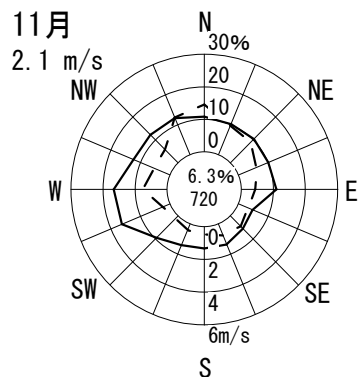
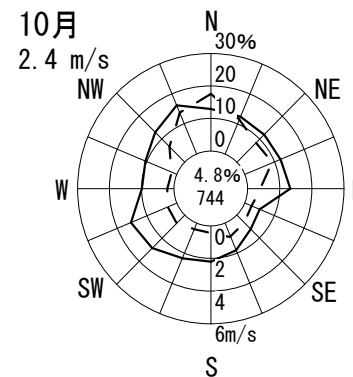
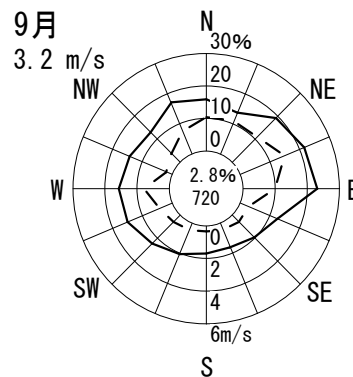
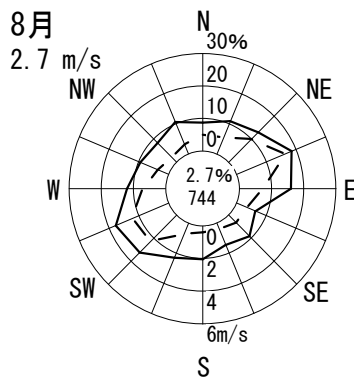
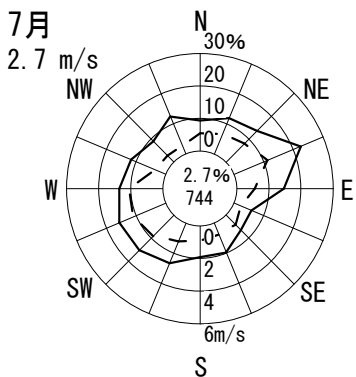
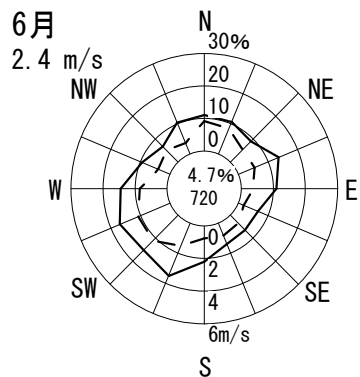
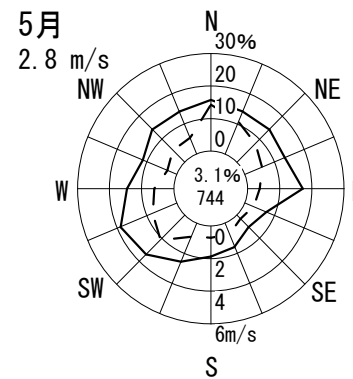
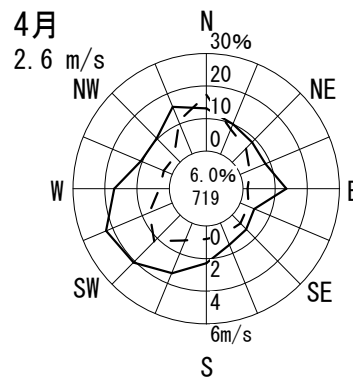
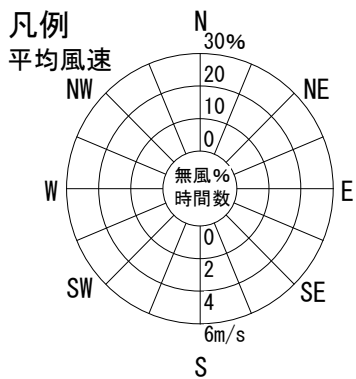
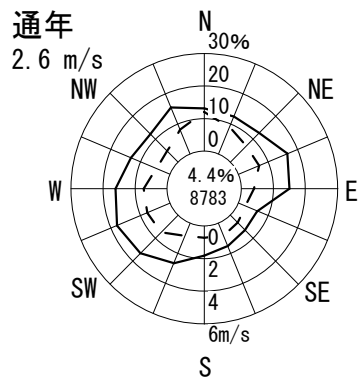



# 風配図 - 月別

測定局：緑ヶ丘小学校

2011年4月～2012年3月 1～24 時

風向風速計高さ 17.8 m

--- 出現頻度

— 平均風速

円内 無風%  
測定時間数

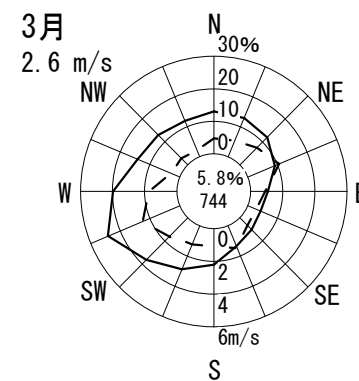
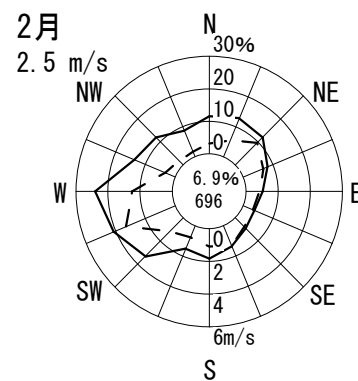
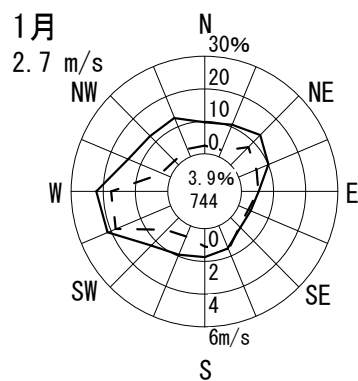
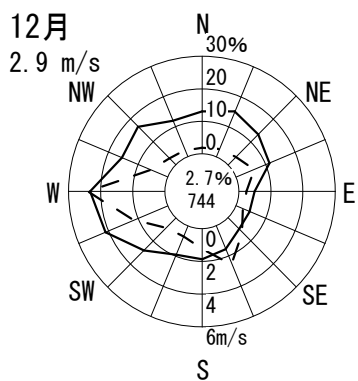
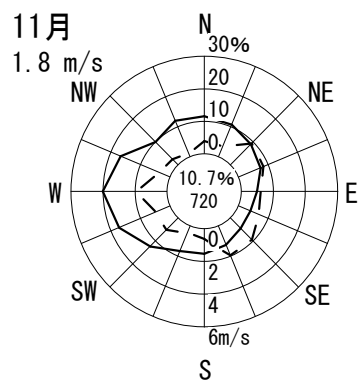
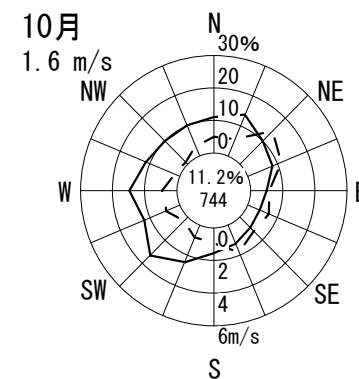
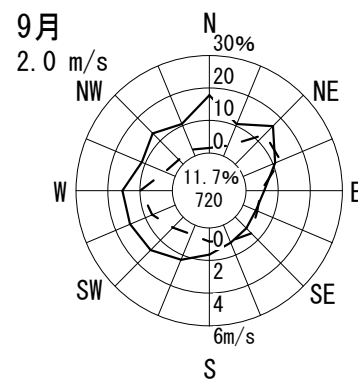
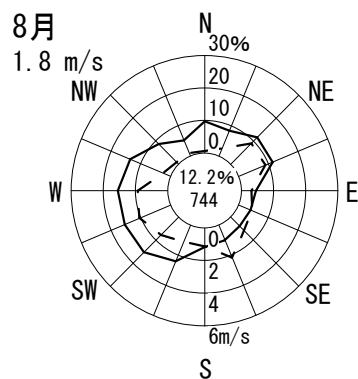
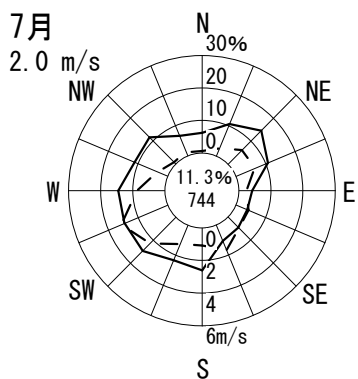
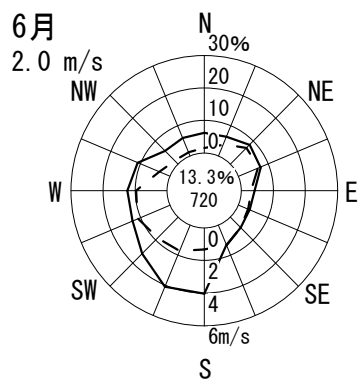
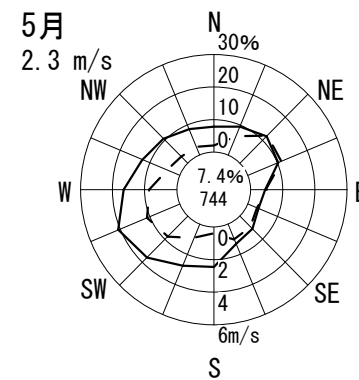
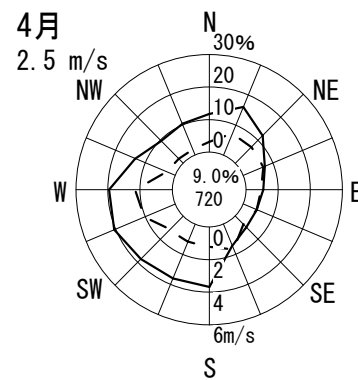
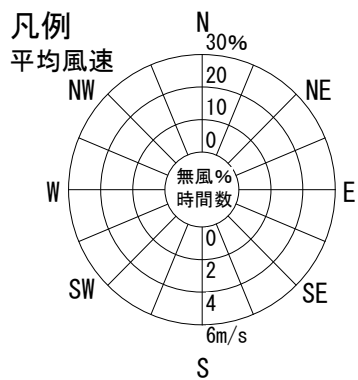
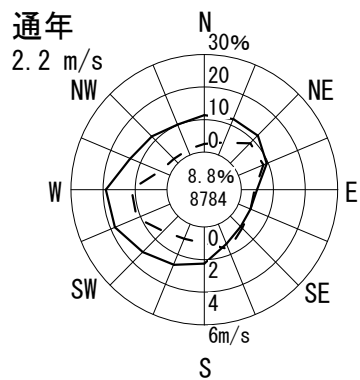

# 風配図 - 月別

測定局：府立修徳学院

2011年4月～2012年3月 1～24 時

風向風速計高さ 15.1 m

--- 出現頻度

— 平均風速

円内 無風%  
測定時間数

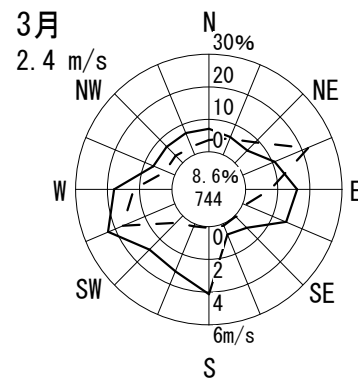
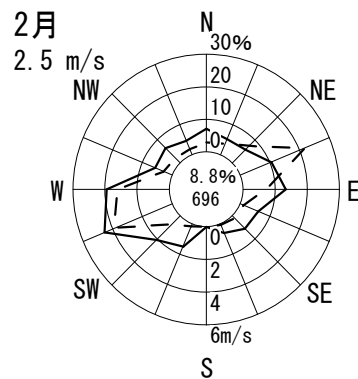
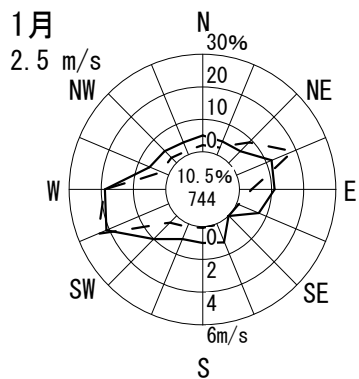
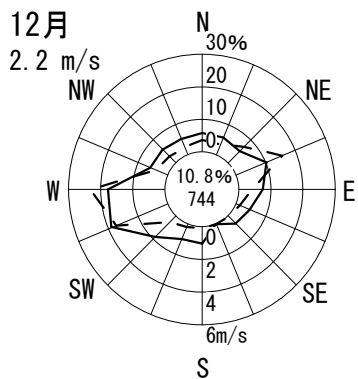
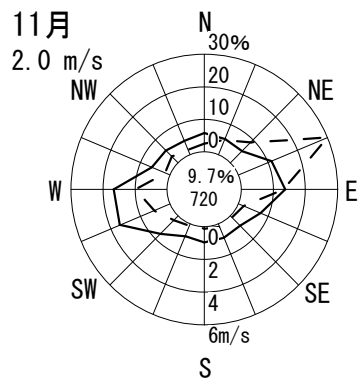
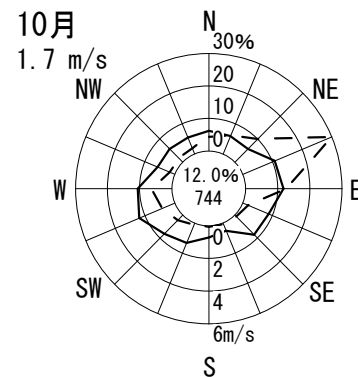
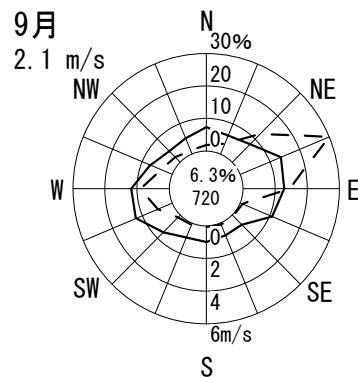
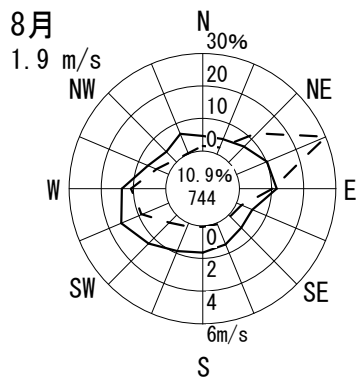
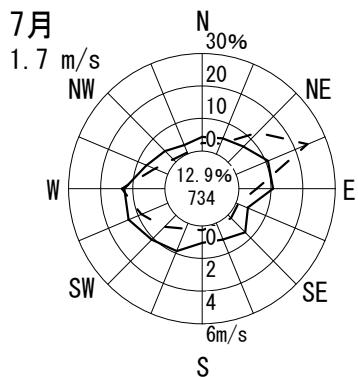
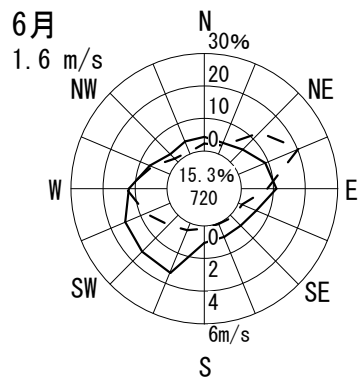
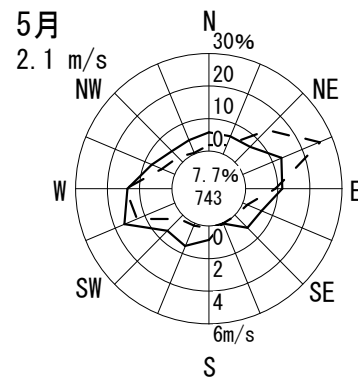
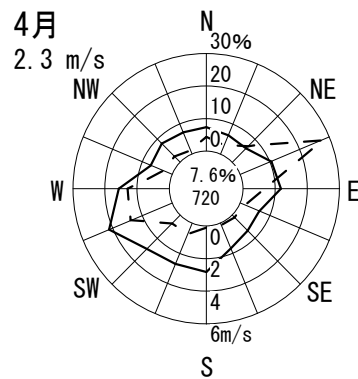
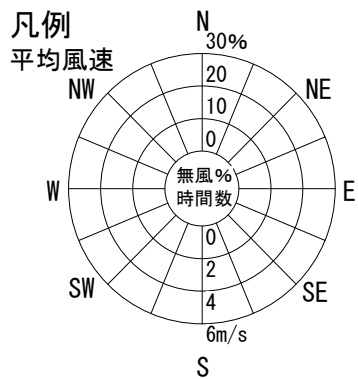
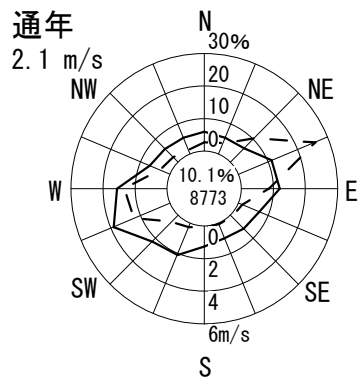

# 風配図 - 月別

測定局：柏原市役所

2011年4月～2012年3月 1～24 時

風向風速計高さ 23.0 m

--- 出現頻度

— 平均風速

円内 無風%  
測定時間数

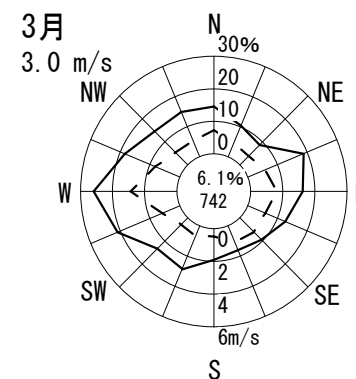
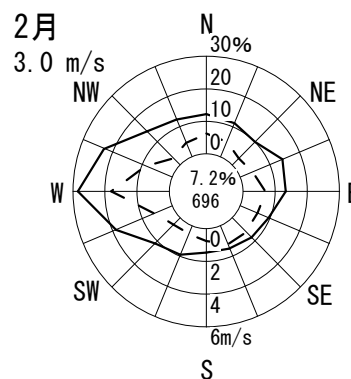
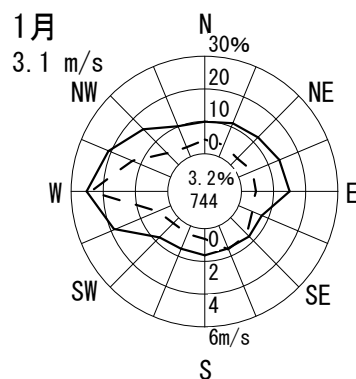
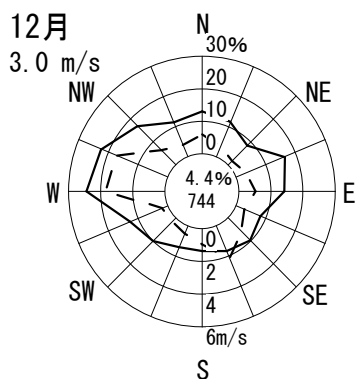
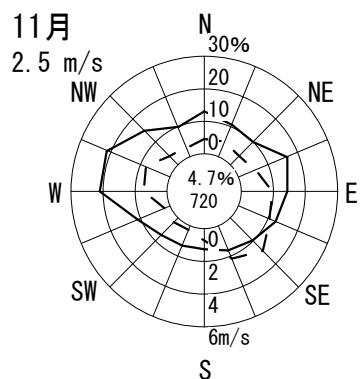
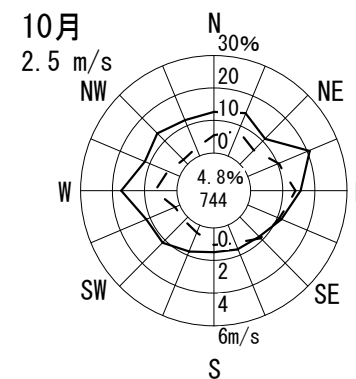
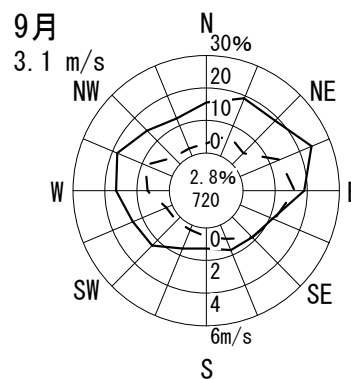
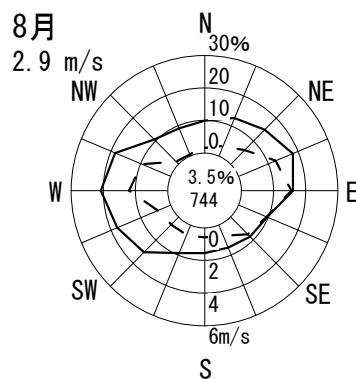
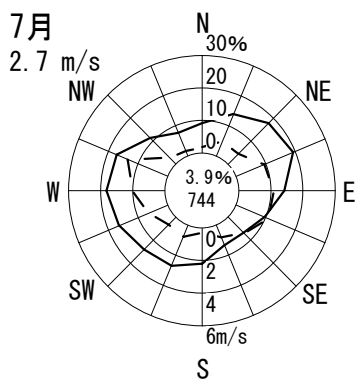
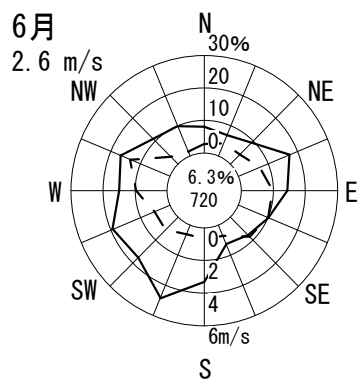
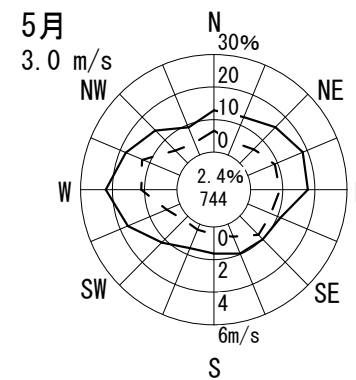
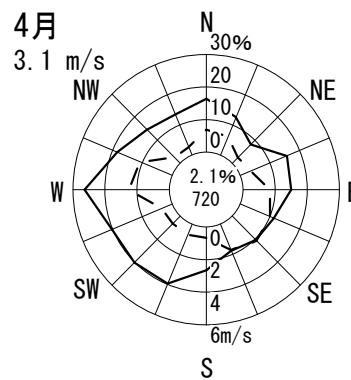
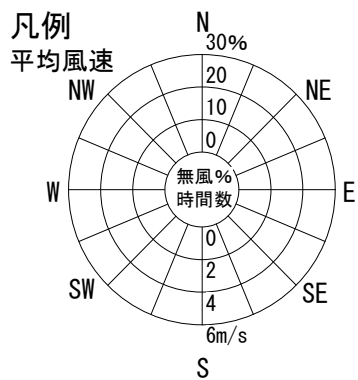
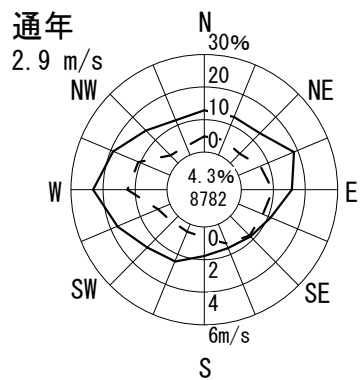

# 風配図 - 月別

測定局：門真市役所

2011年4月～2012年3月 1～24 時

風向風速計高さ 16.0 m

--- 出現頻度  
—— 平均風速

円内 無風%  
測定時間数

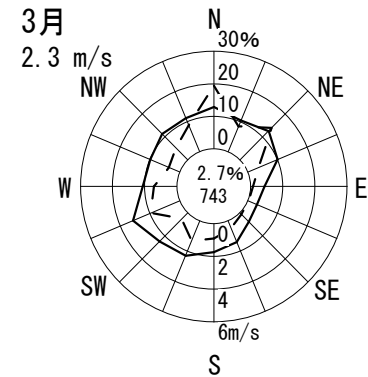
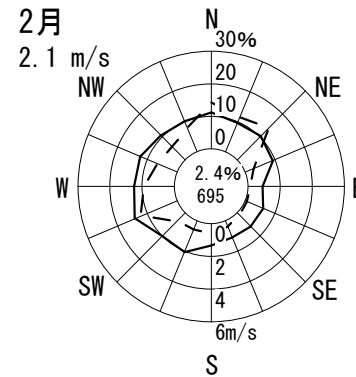
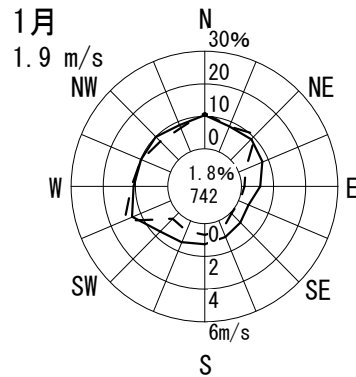
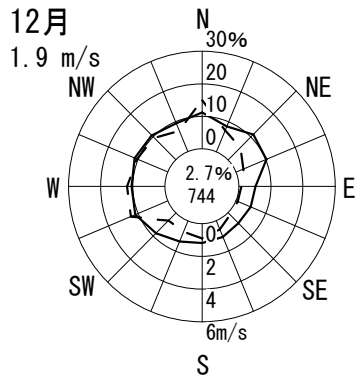
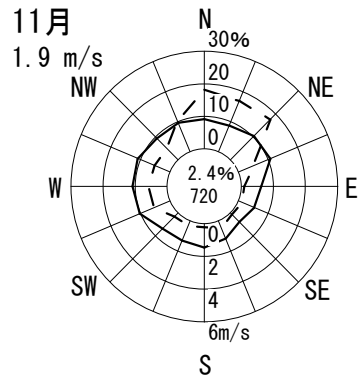
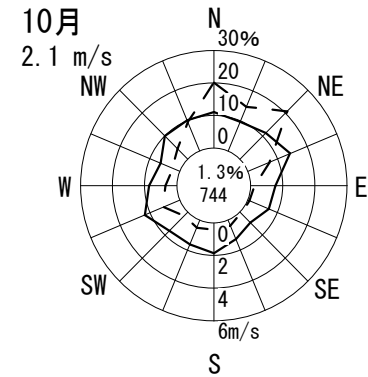
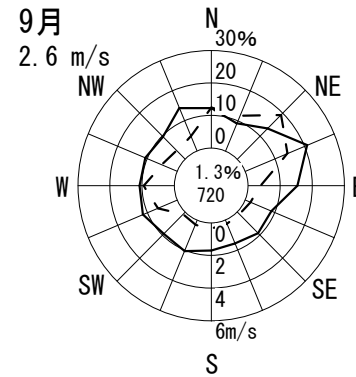
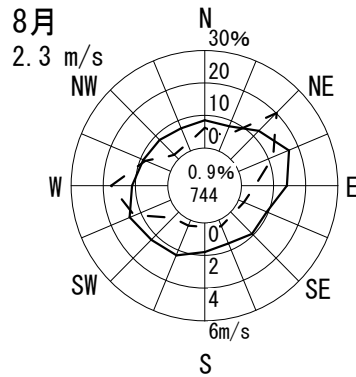
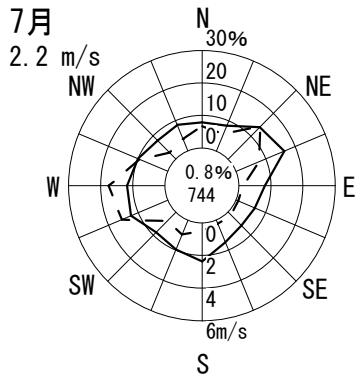
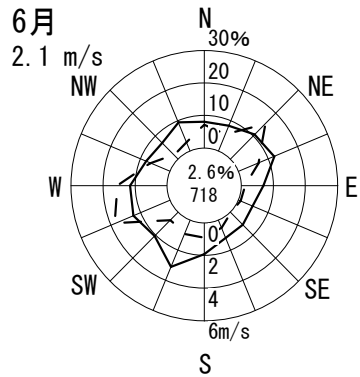
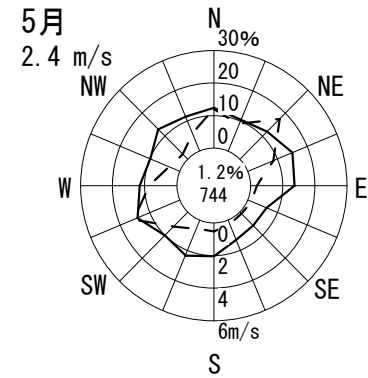
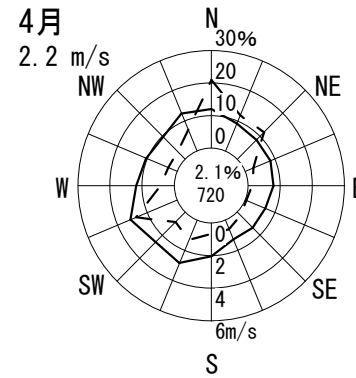
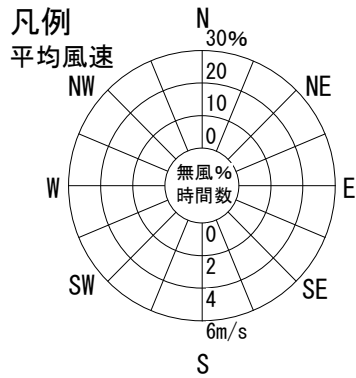
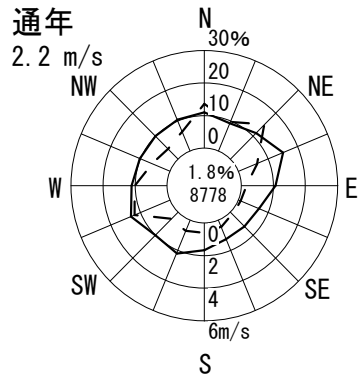

# 風配図 - 月別

測定局：門真市南

2011年4月～2012年3月 1～24 時

風向風速計高さ 6.3 m

--- 出現頻度

— 平均風速

円内 無風%  
測定時間数

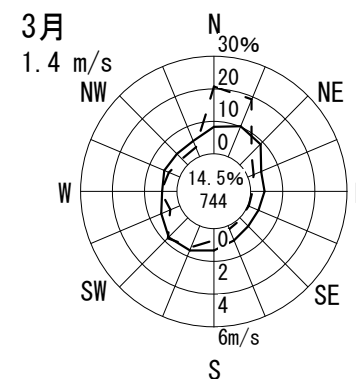
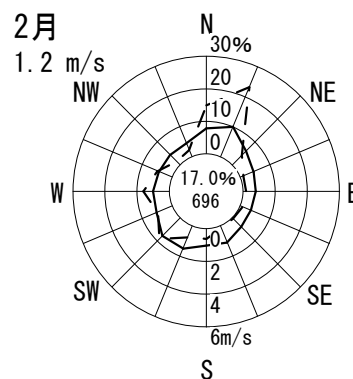
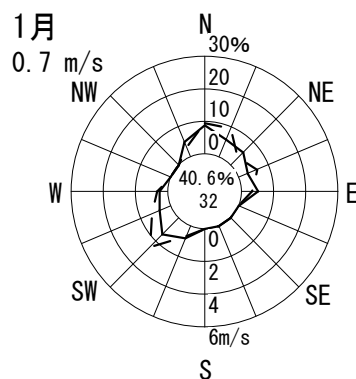
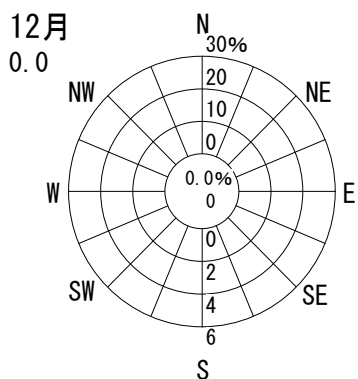
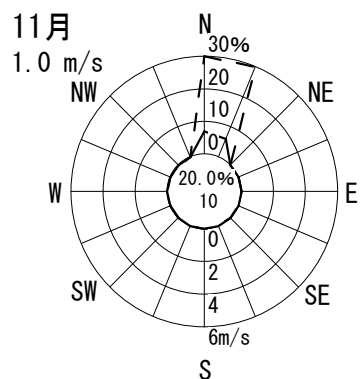
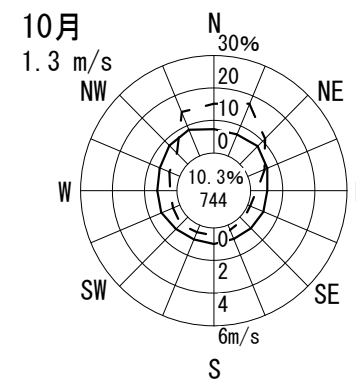
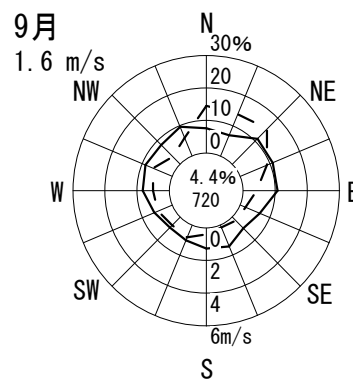
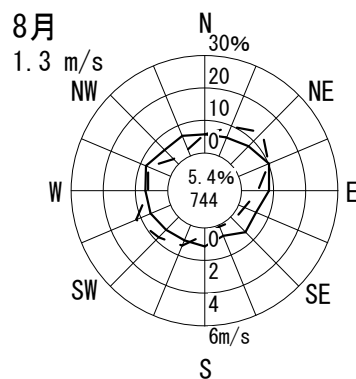
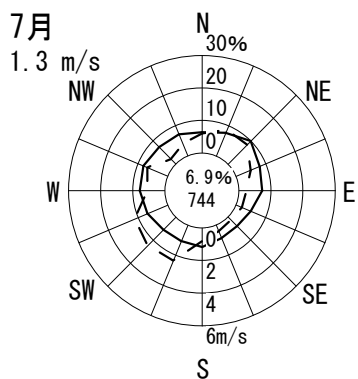
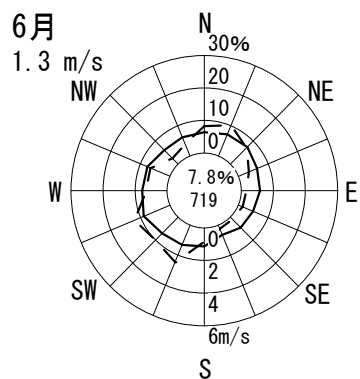
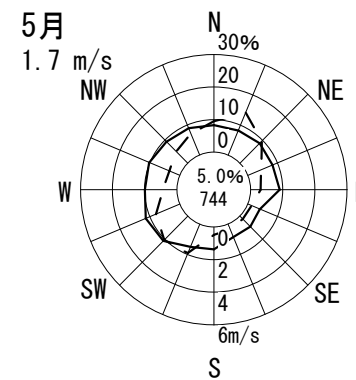
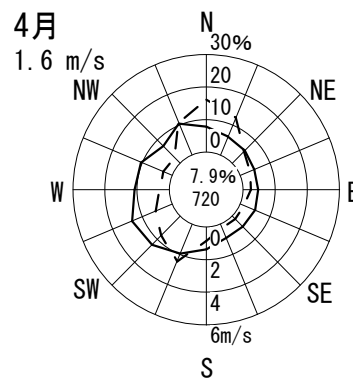
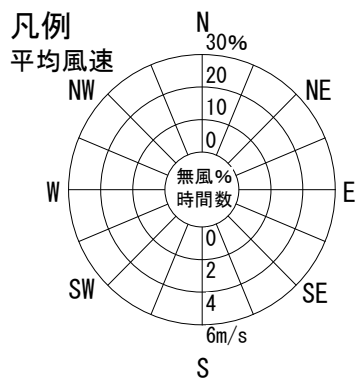
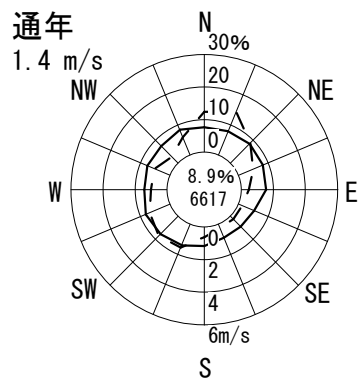

# 風配図 - 月別

測定局：高石中学校

2011年4月～2012年3月 1～24 時

風向風速計高さ 18.0 m

--- 出現頻度  
—— 平均風速

円内 無風%  
測定時間数

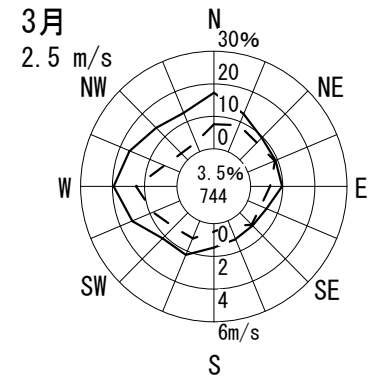
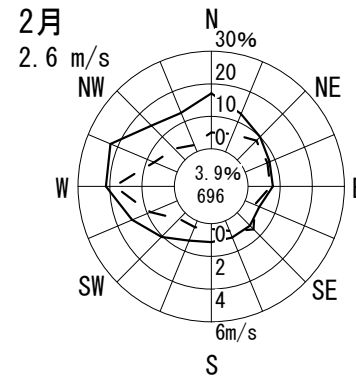
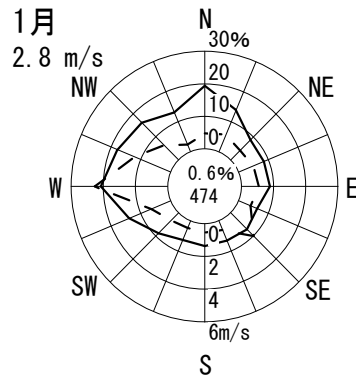
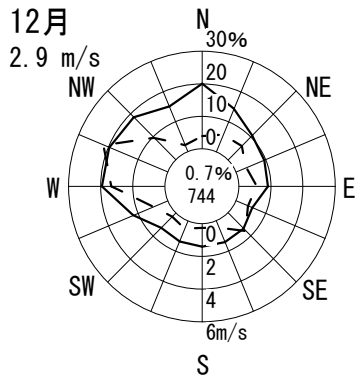
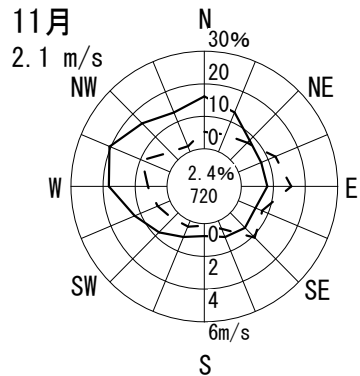
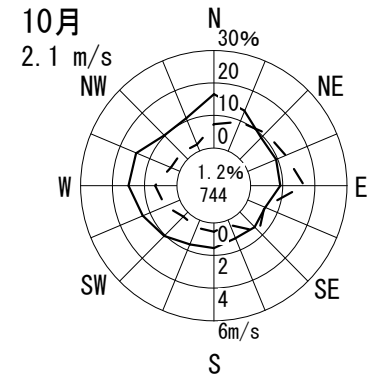
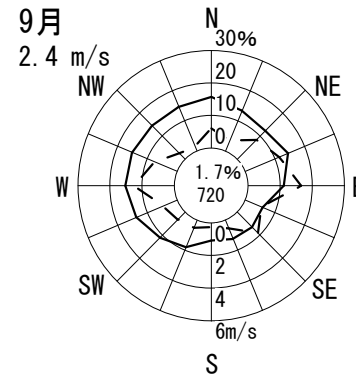
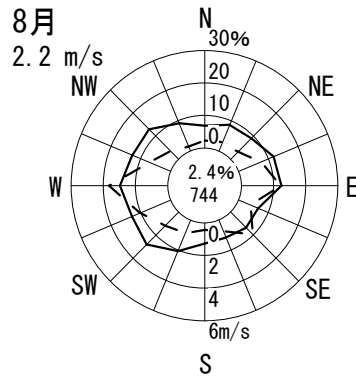
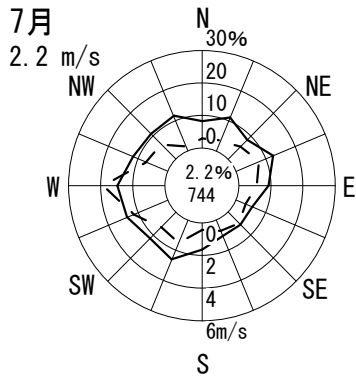
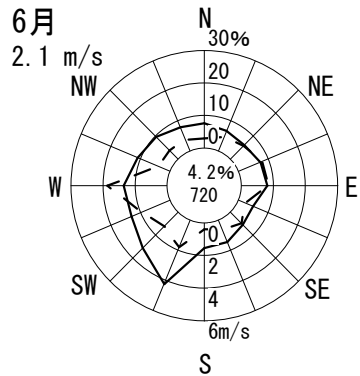
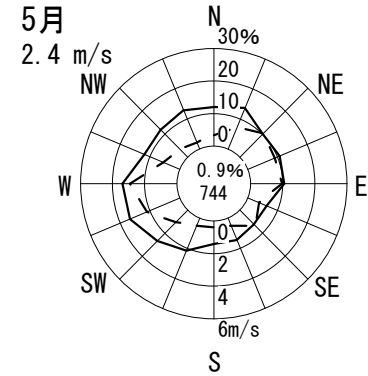
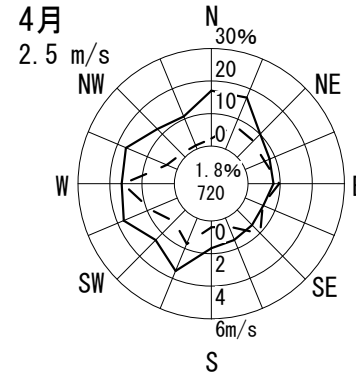
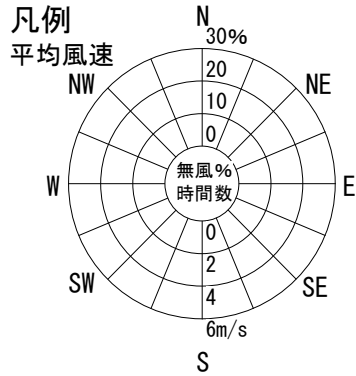
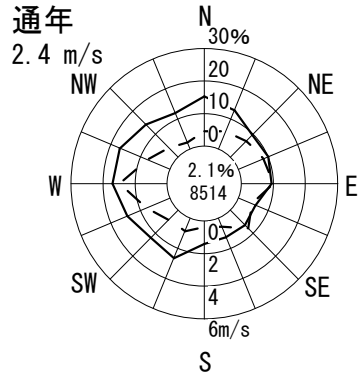

# 風配図 - 月別

測定局：高石消防署高師浜出張所

2011年4月～2012年3月 1～24 時

風向風速計高さ 14.2 m

--- 出現頻度

— 平均風速

円内 無風%  
測定時間数

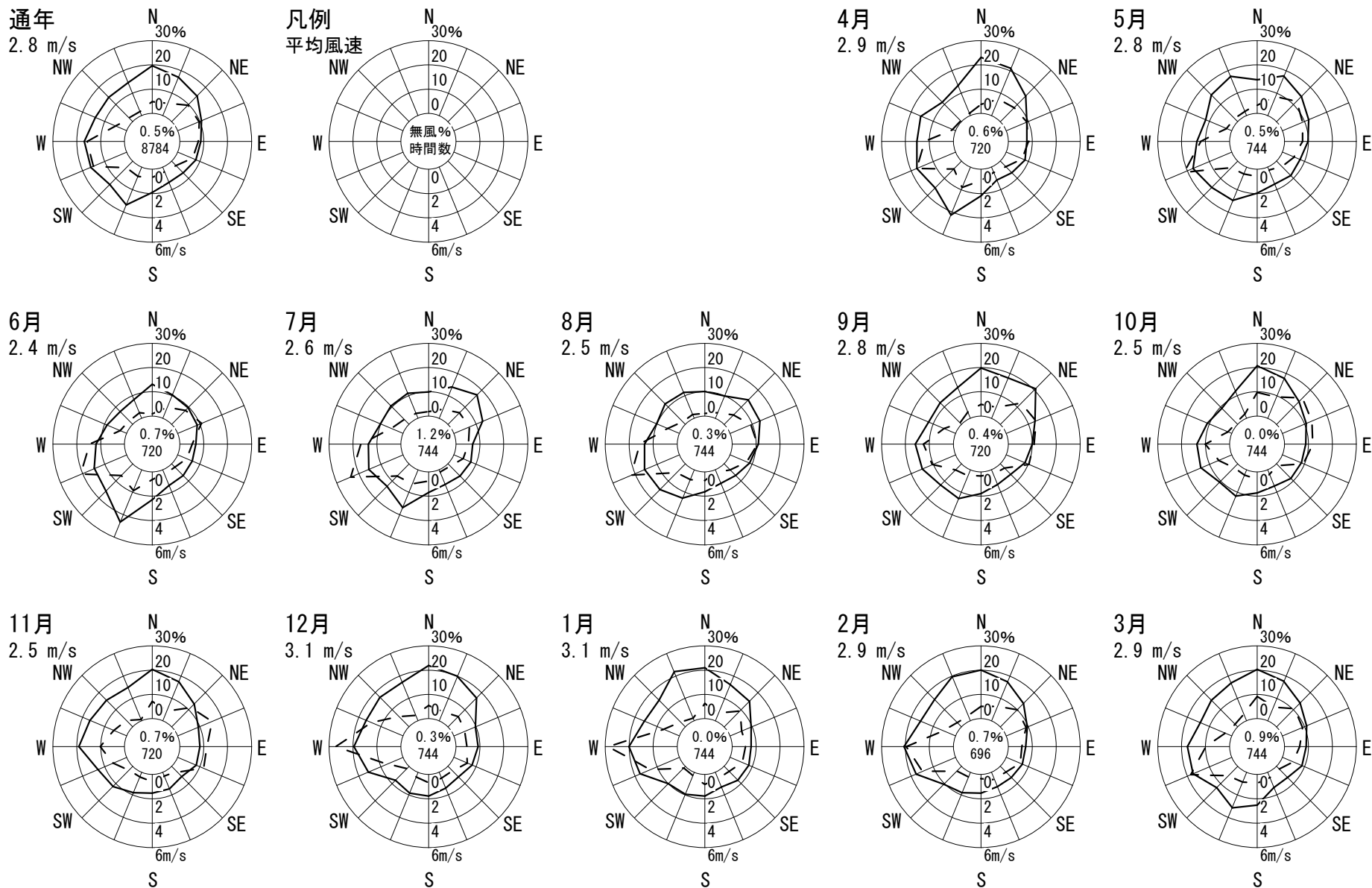

# 風配図 - 月別

測定局：藤井寺市役所

2011年4月～2012年3月 1～24 時

風向風速計高さ 45.1 m

--- 出現頻度  
—— 平均風速

円内 無風%  
測定時間数

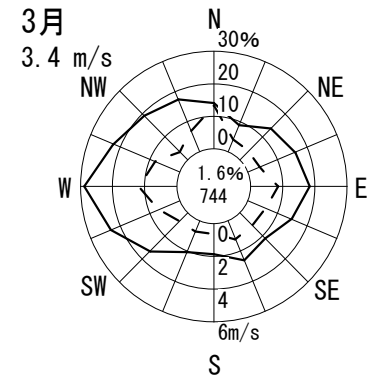
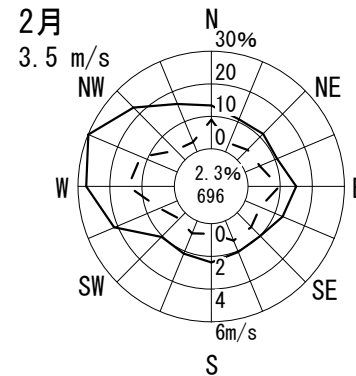
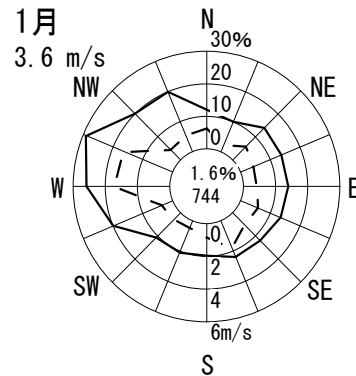
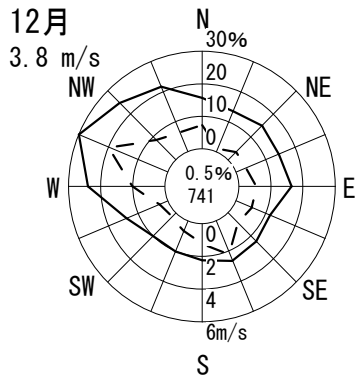
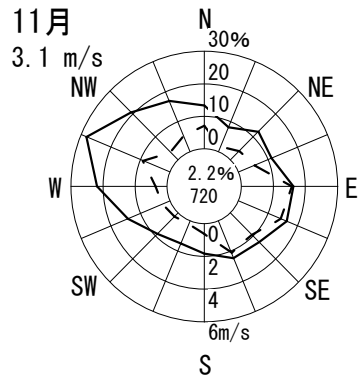
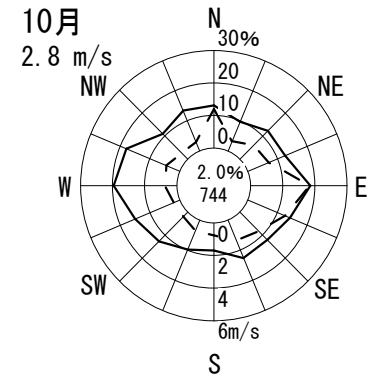
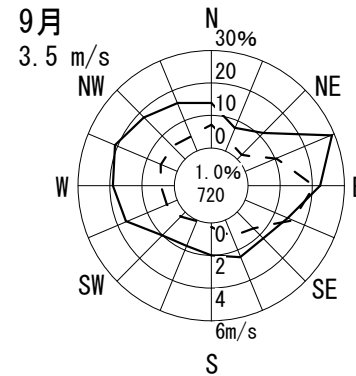
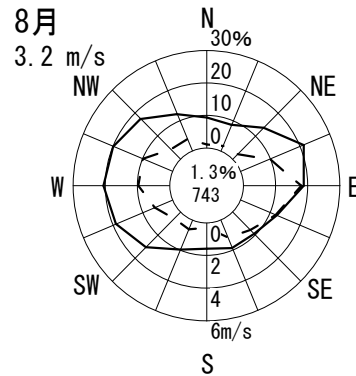
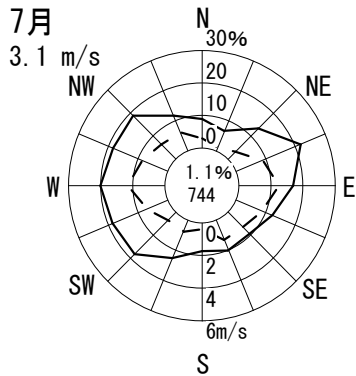
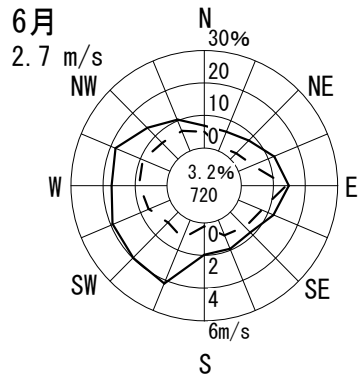
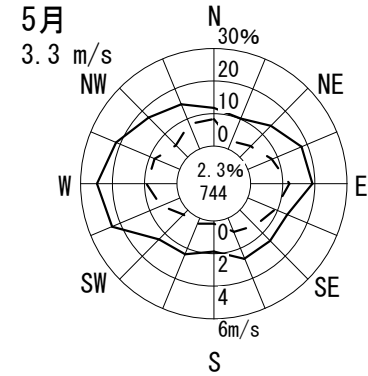
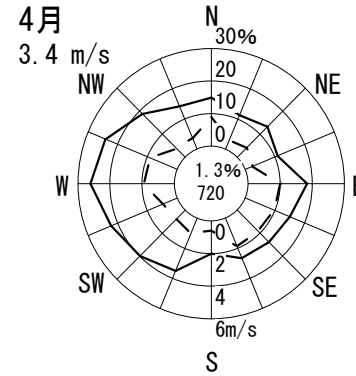
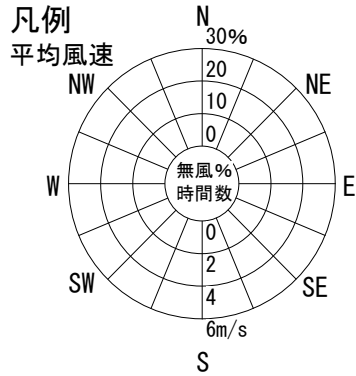
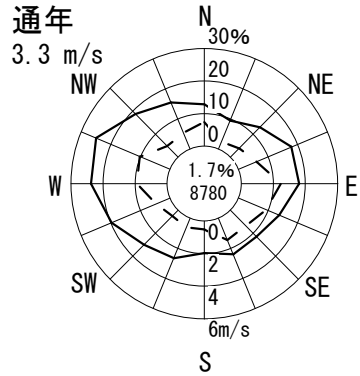



# 風配図 - 月別

測定局：道明寺東小学校

2011年4月～2012年3月 1～24 時

風向風速計高さ 10.0 m

--- 出現頻度

— 平均風速

○内 無風%  
測定時間数

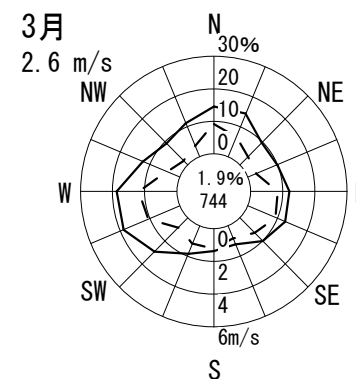
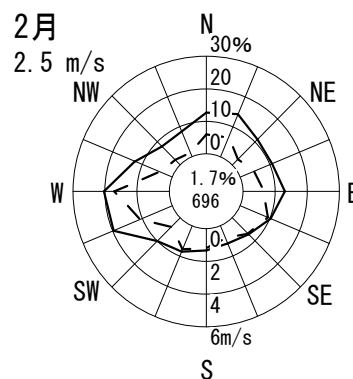
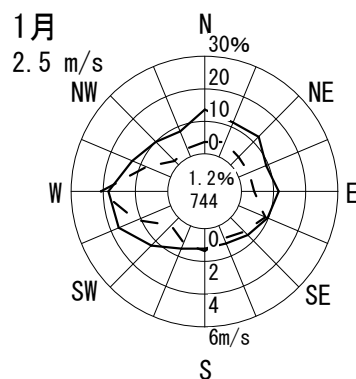
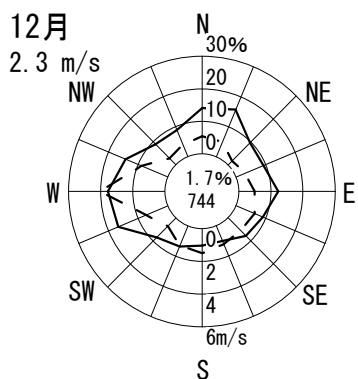
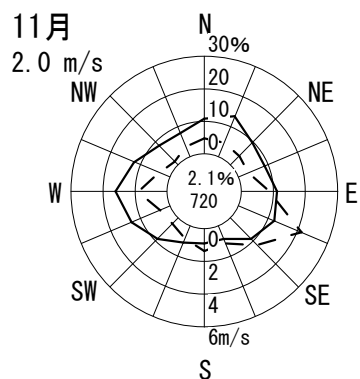
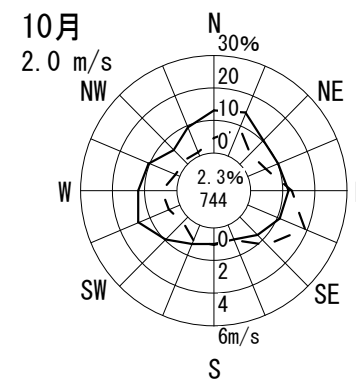
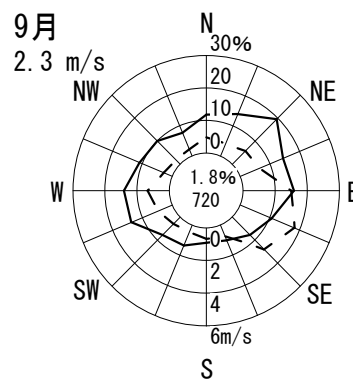
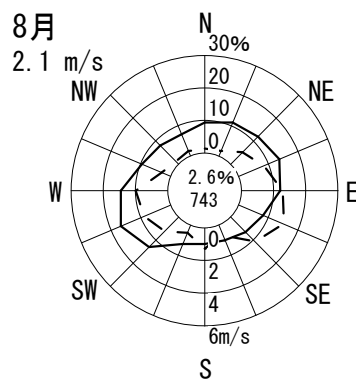
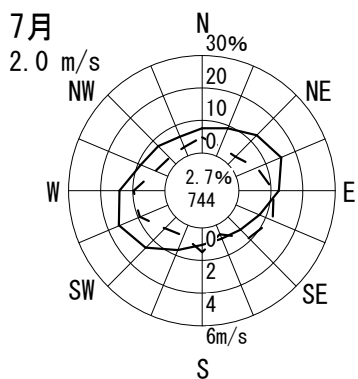
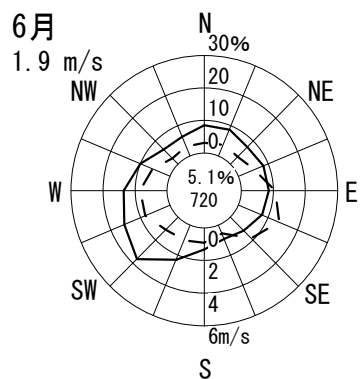
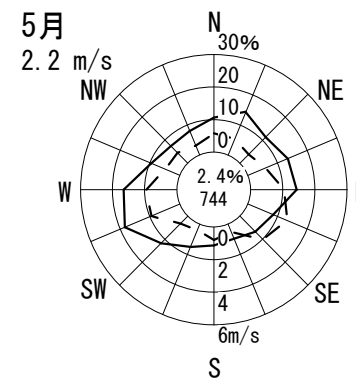
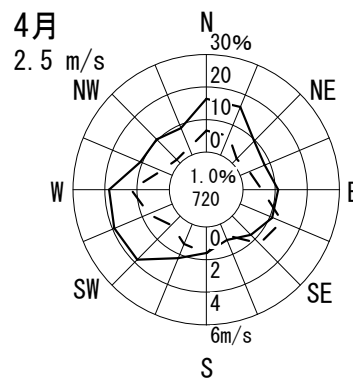
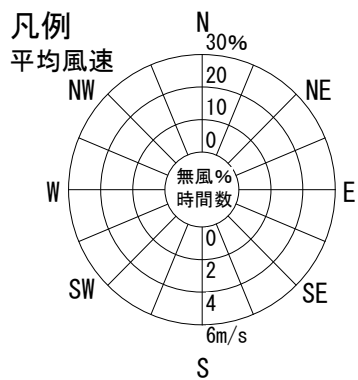
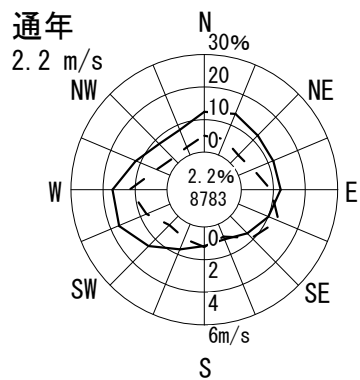

# 風配図 - 月別

測定局：東大阪市西保健センター

2011年4月～2012年3月 1～24 時

風向風速計高さ 15.3 m

--- 出現頻度  
—— 平均風速

円内 無風%  
測定時間数

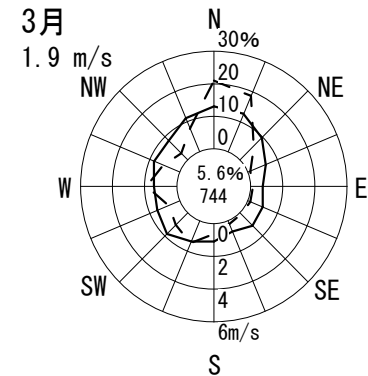
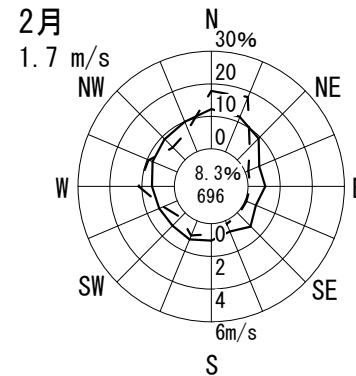
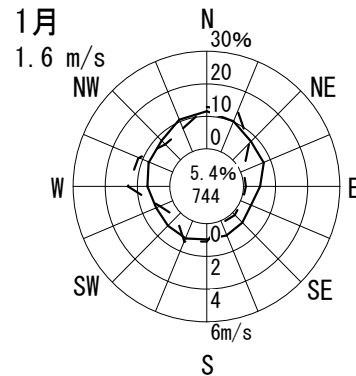
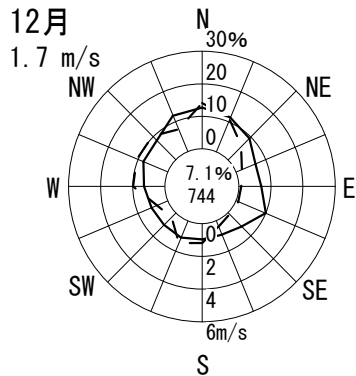
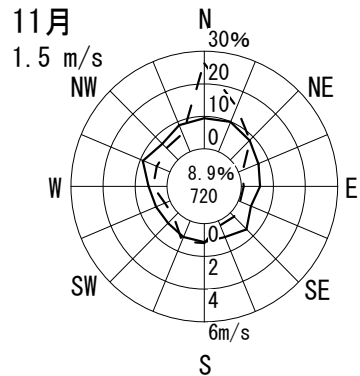
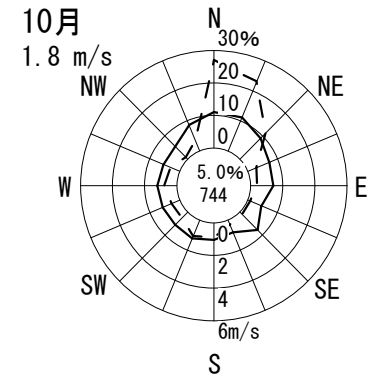
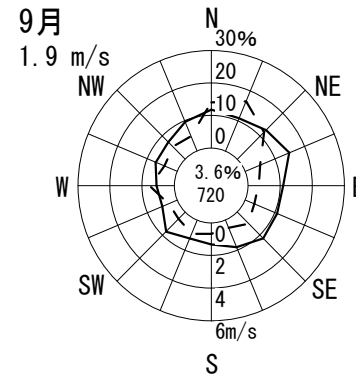
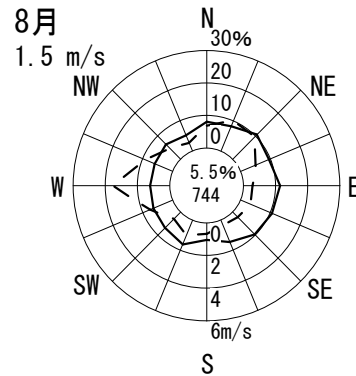
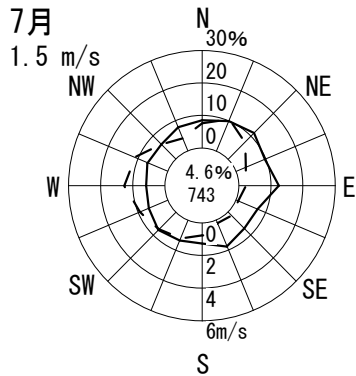
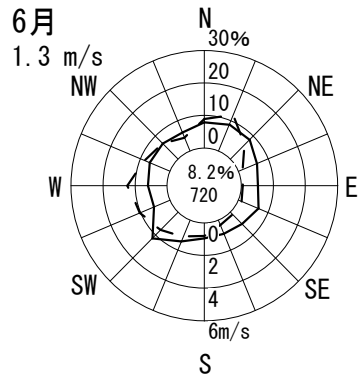
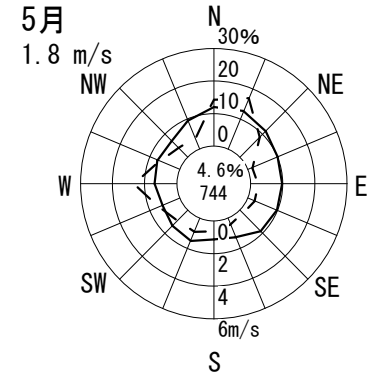
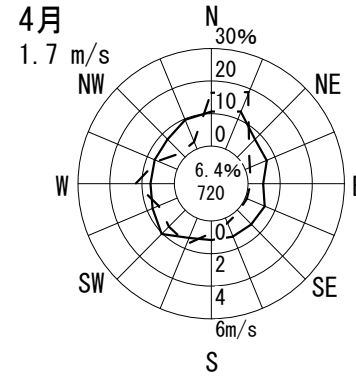
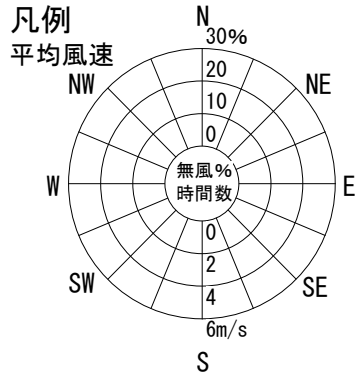
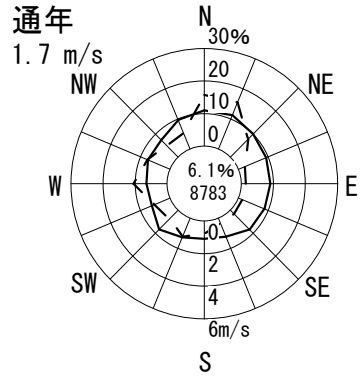

# 風配図 - 月別

測定局：東大阪市旭町庁舎

2011年4月～2012年3月 1～24 時

風向風速計高さ 27.6 m

--- 出現頻度

— 平均風速

円内 無風%  
測定時間数

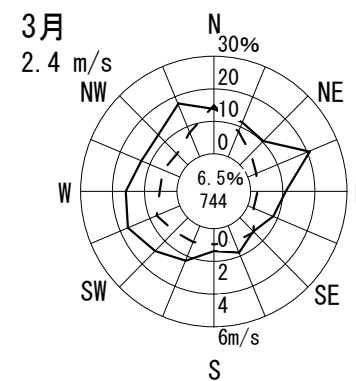
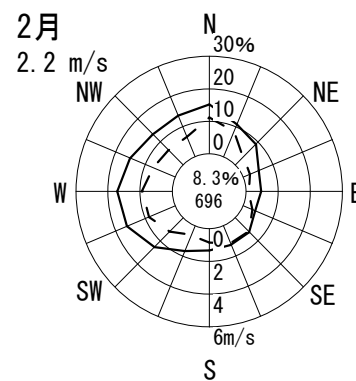
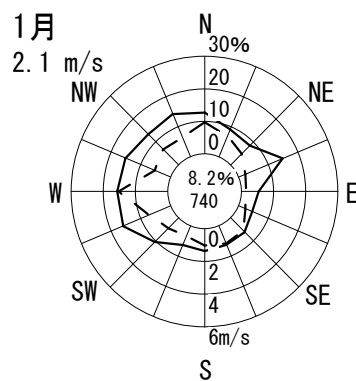
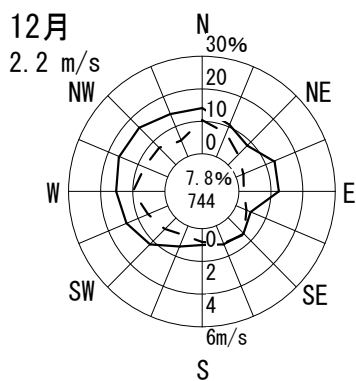
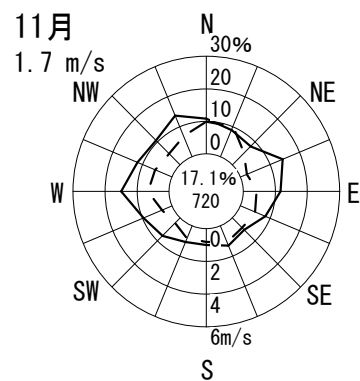
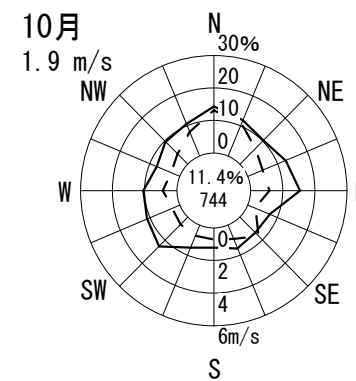
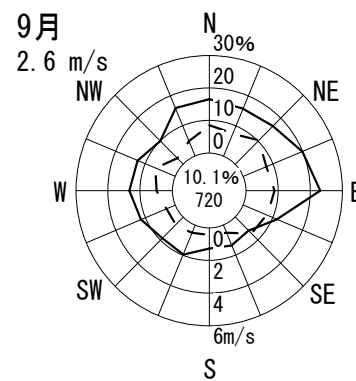
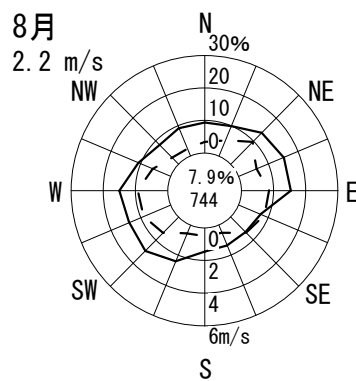
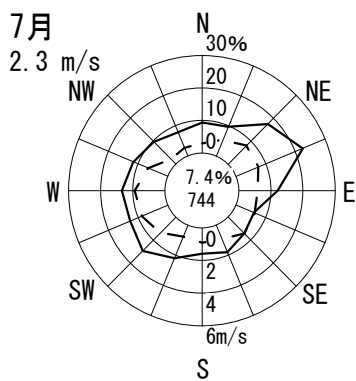
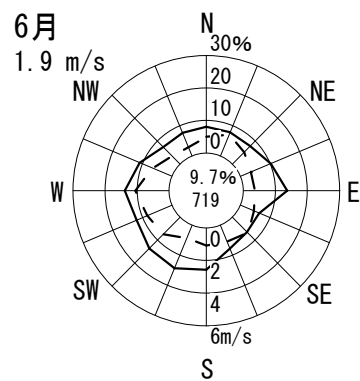
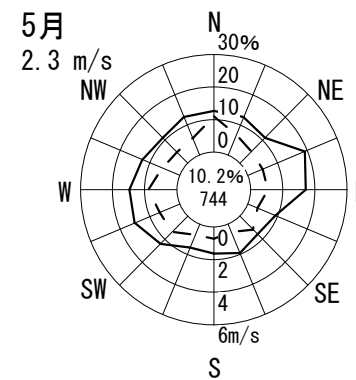
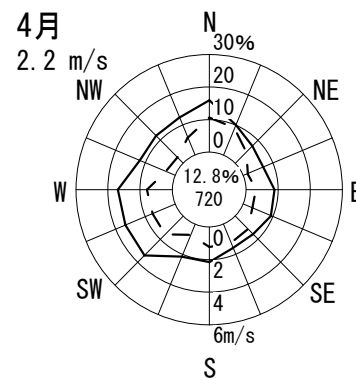
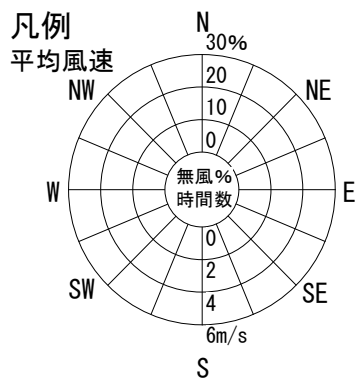
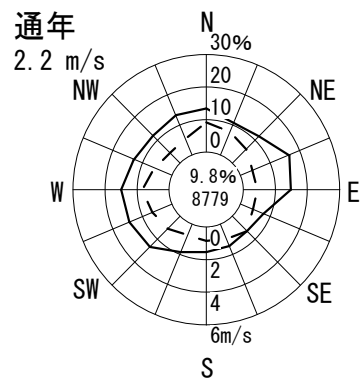

# 風配図 - 月別

測定局：泉南市役所

2011年4月～2012年3月 1～24 時

風向風速計高さ 15.5 m

--- 出現頻度

— 平均風速

円内 無風%  
測定時間数

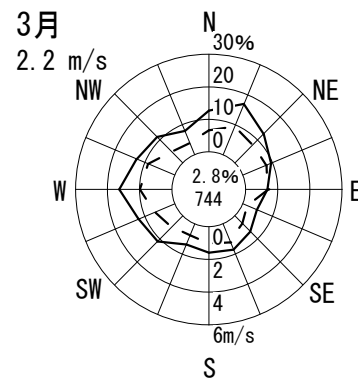
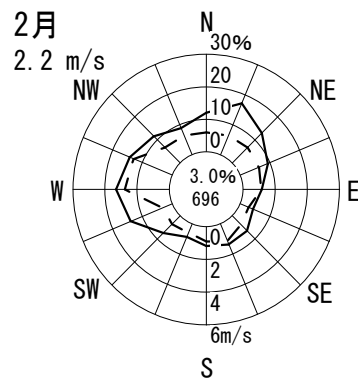
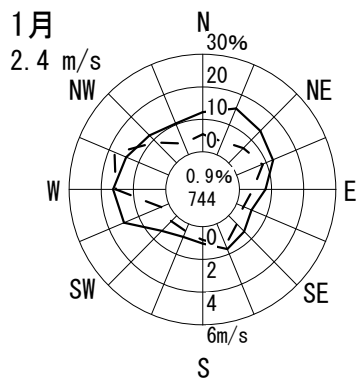
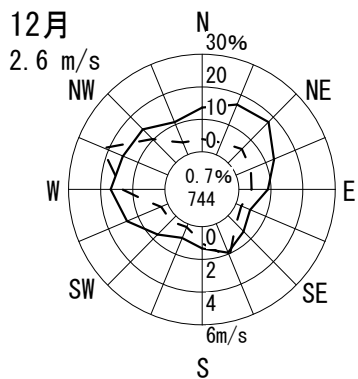
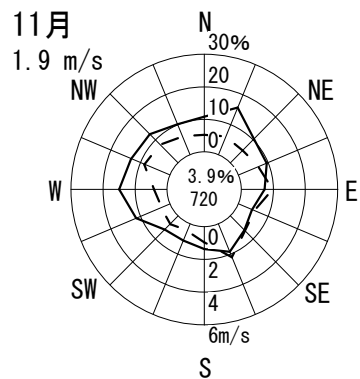
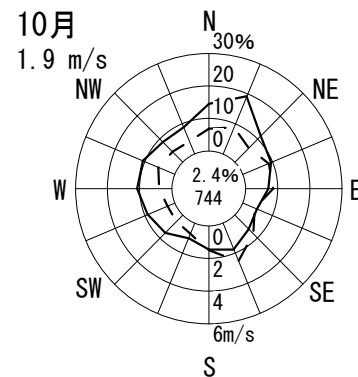
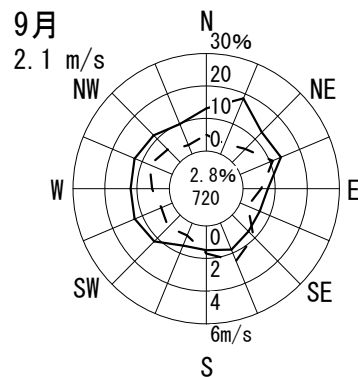
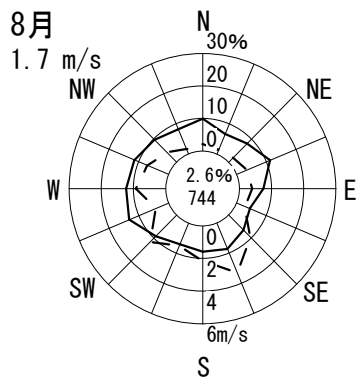
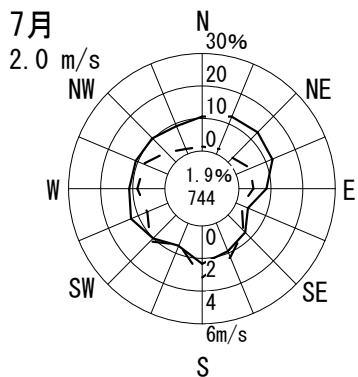
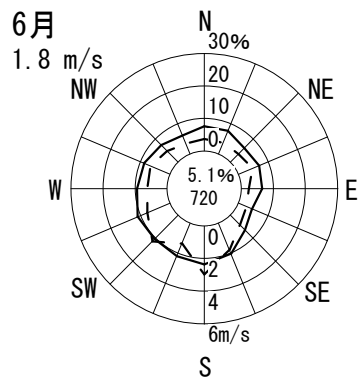
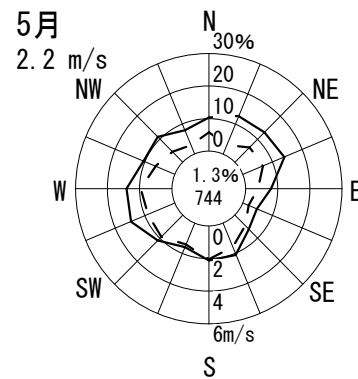
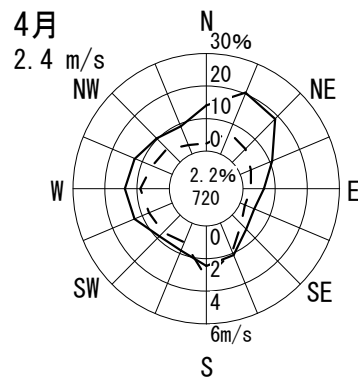
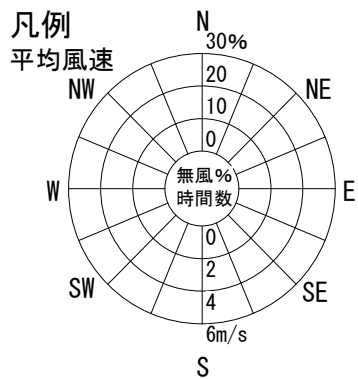
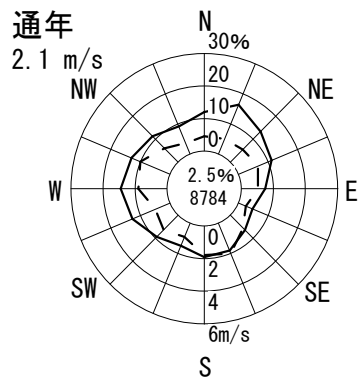

# 風配図 - 月別

測定局：南海団地

2011年4月～2012年3月 1～24 時

風向風速計高さ 10.7 m

--- 出現頻度

— 平均風速

○内 無風%  
測定時間数

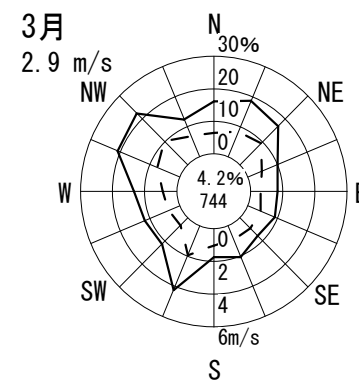
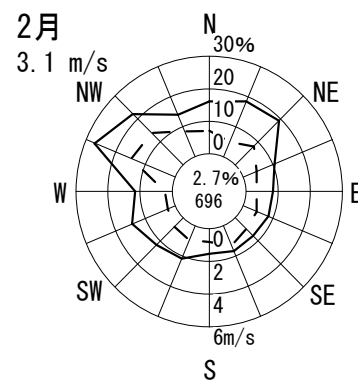
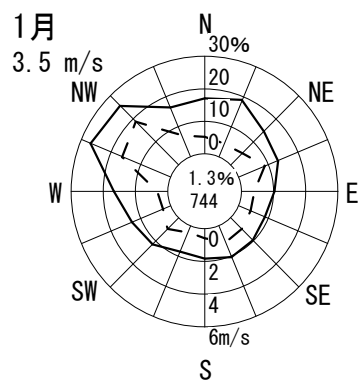
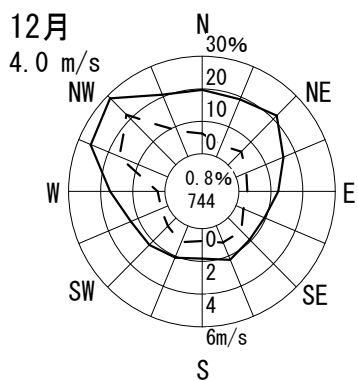
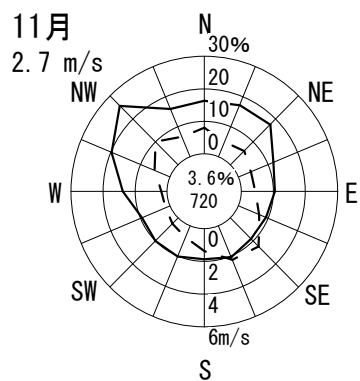
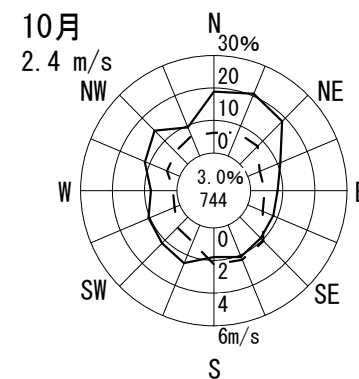
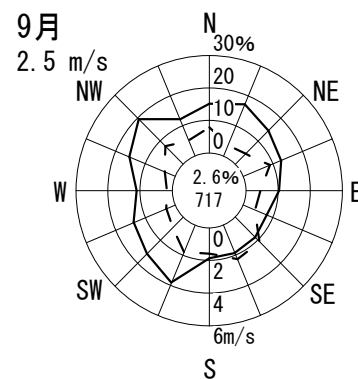
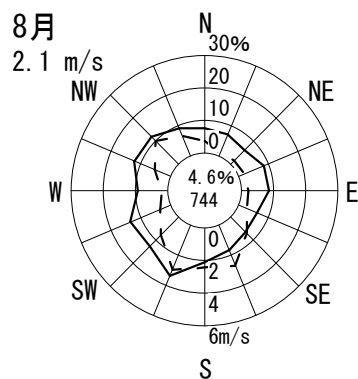
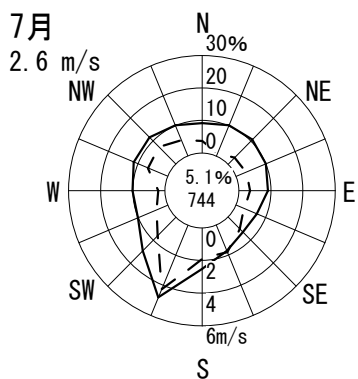
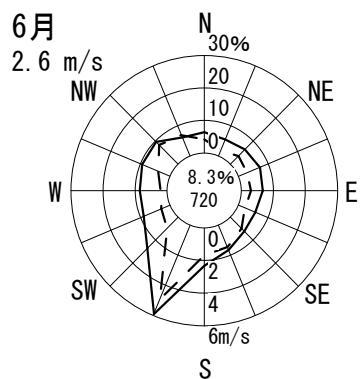
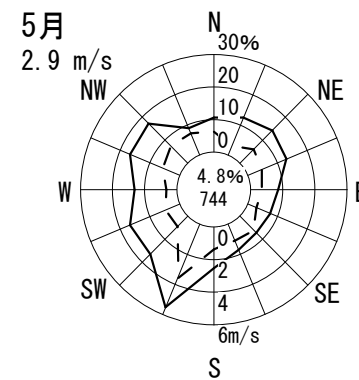
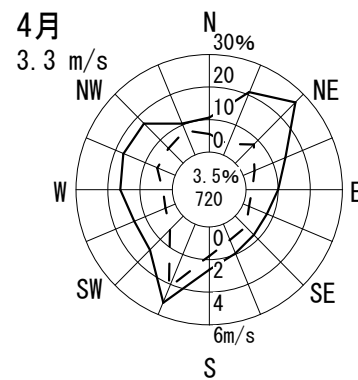
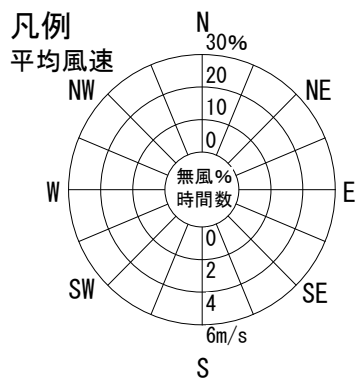
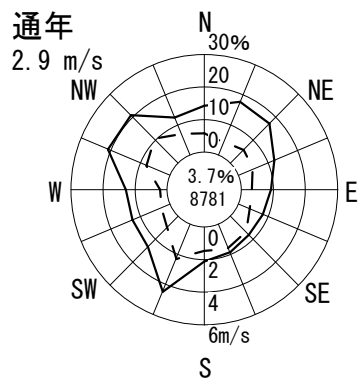

# 風配図 - 月別

測定局：島本町役場

2011年4月～2012年3月 1～24 時

風向風速計高さ 21.0 m

--- 出現頻度

— 平均風速

円内 無風%  
測定時間数

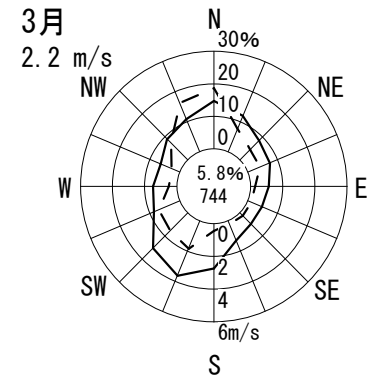
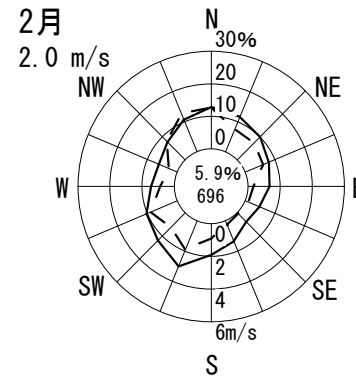
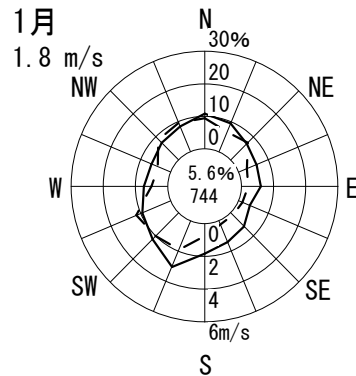
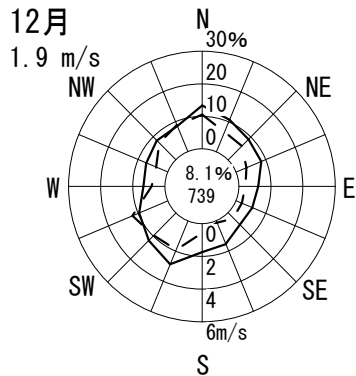
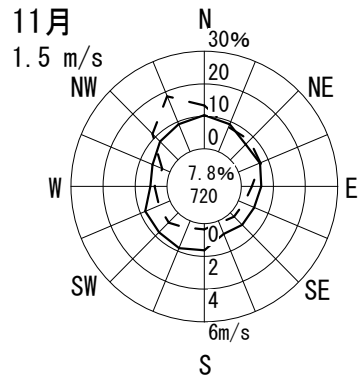
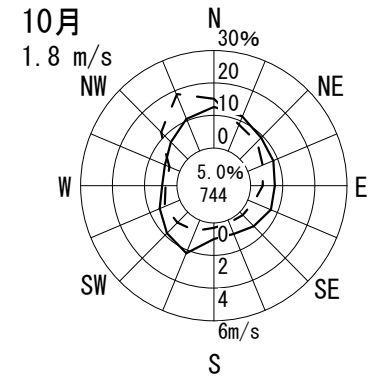
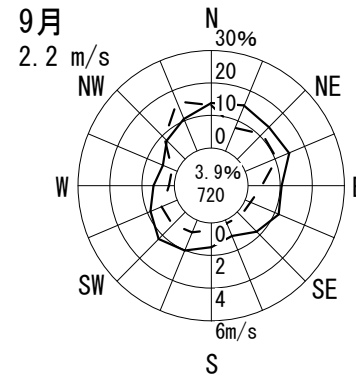
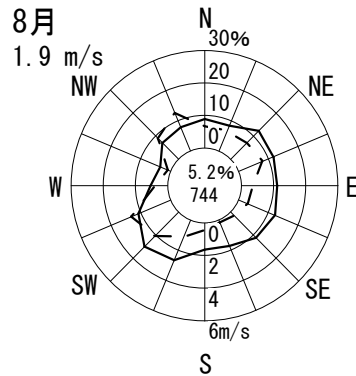
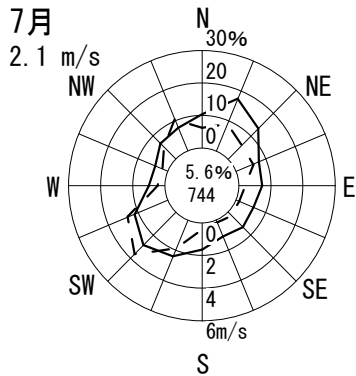
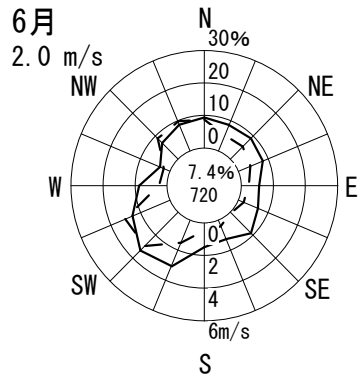
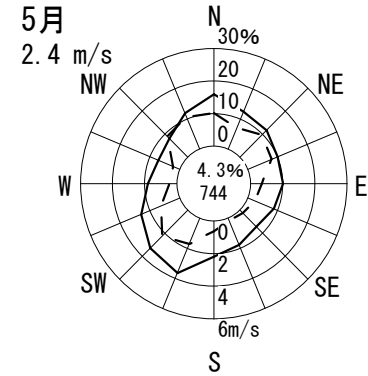
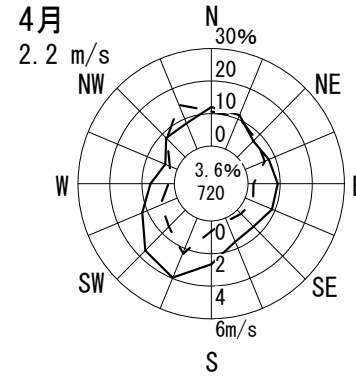
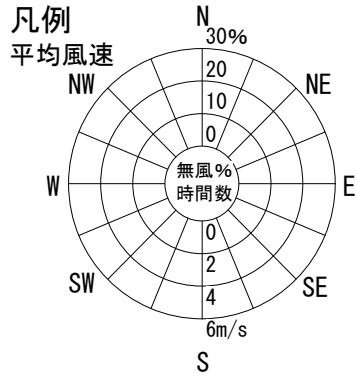
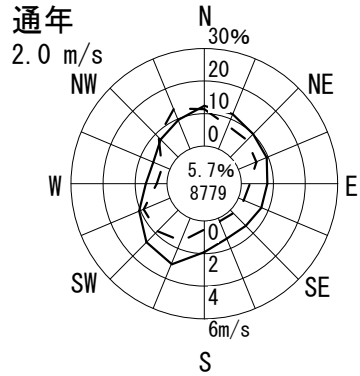

# 風配図 - 月別

測定局：豊能町役場

2011年4月～2012年3月 1～24 時

風向風速計高さ 16.5 m

--- 出現頻度

— 平均風速

○内 無風%  
測定時間数

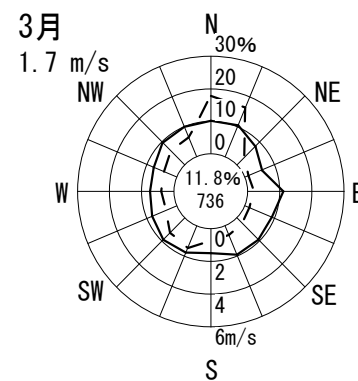
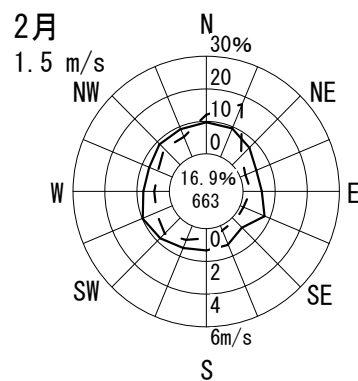
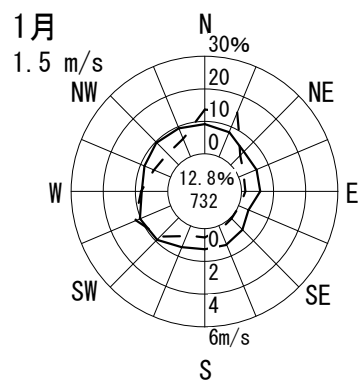
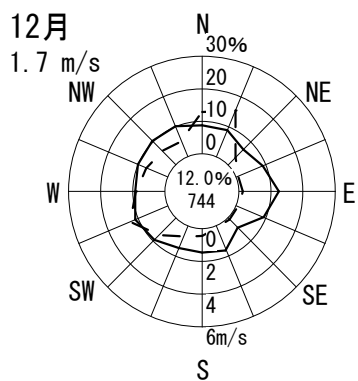
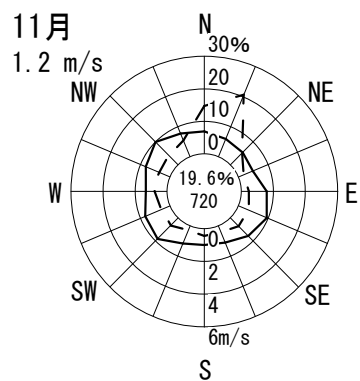
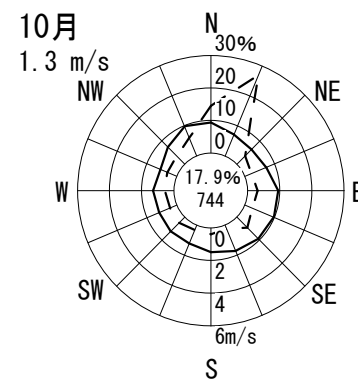
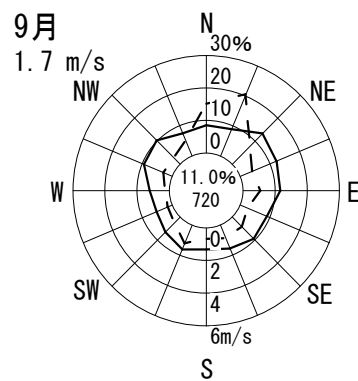
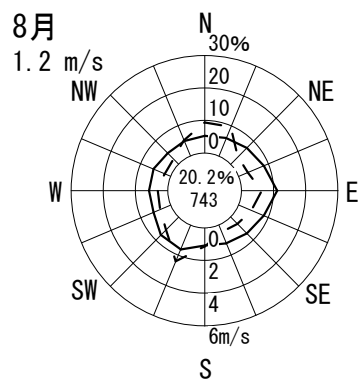
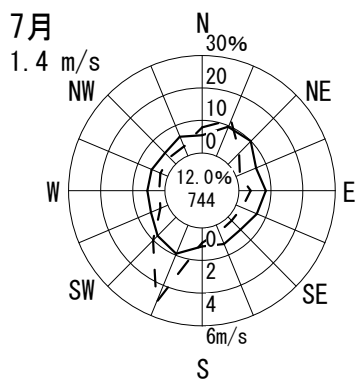
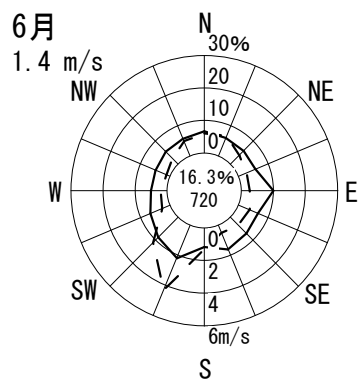
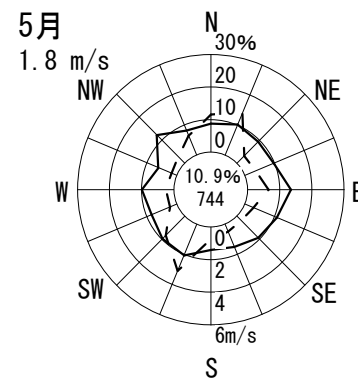
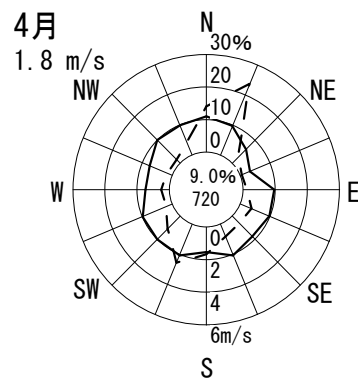
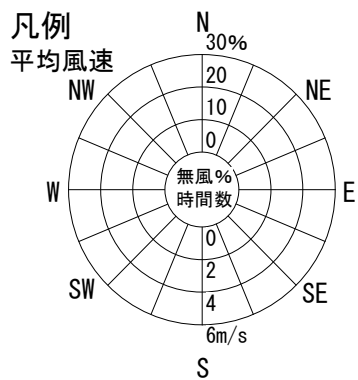
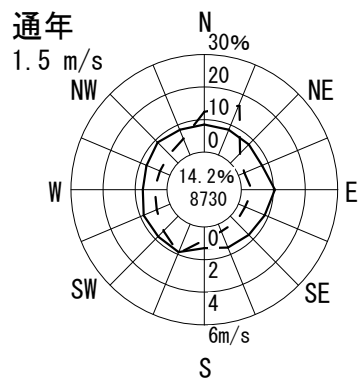

# 風配図 - 月別

測定局：中環

2011年4月～2012年3月 1～24 時

風向風速計高さ 5.5 m

--- 出現頻度

— 平均風速

円内 無風%  
測定時間数

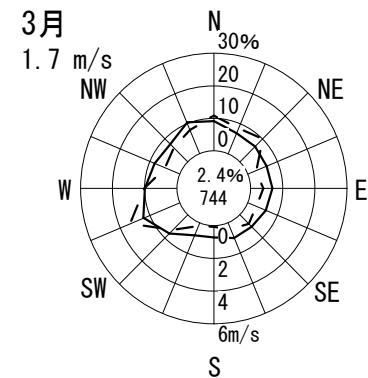
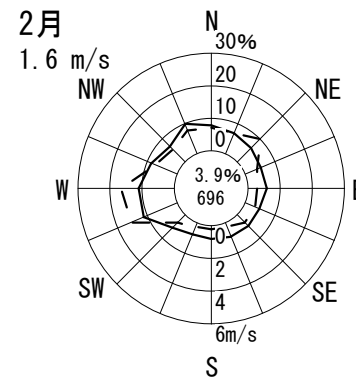
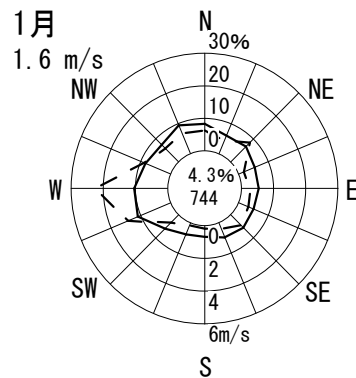
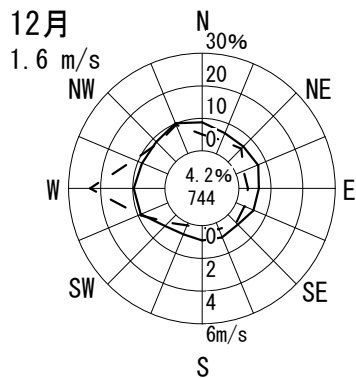
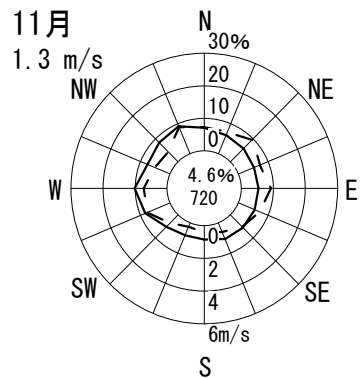
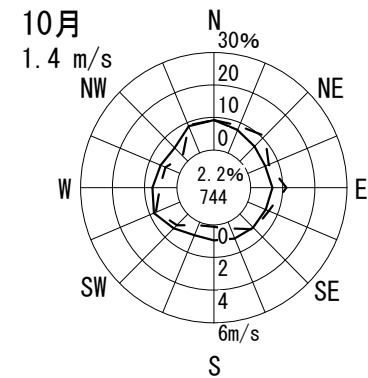
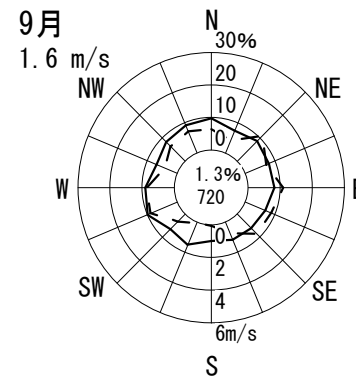
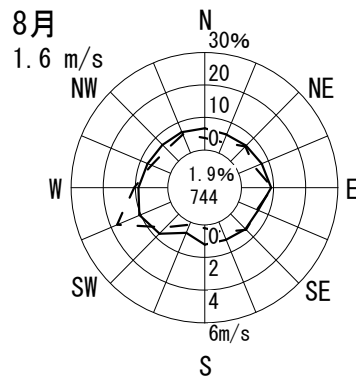
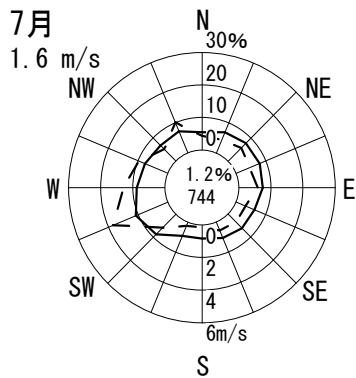
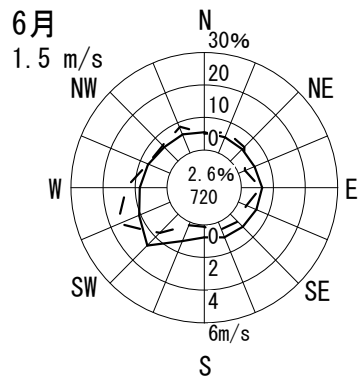
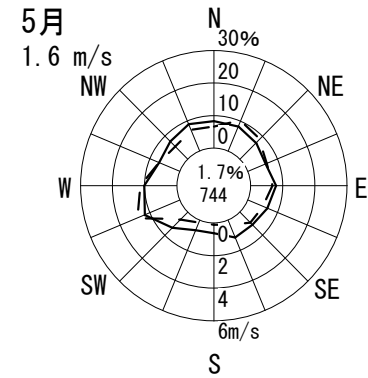
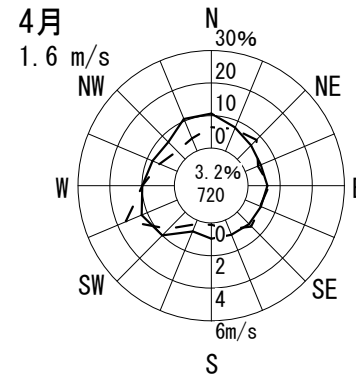
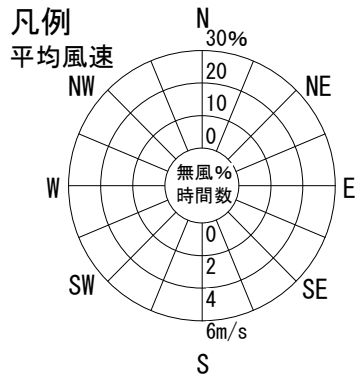
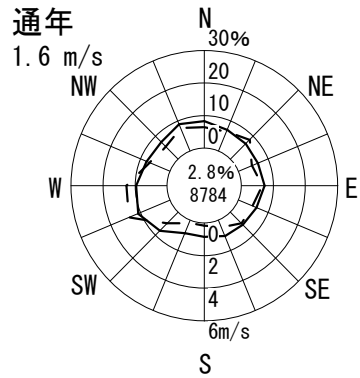



# 風配図 - 月別

測定局：阪和深井畑山

2011年4月～2012年3月 1～24 時

風向風速計高さ 8.0 m

--- 出現頻度

— 平均風速

○内 無風%  
測定時間数

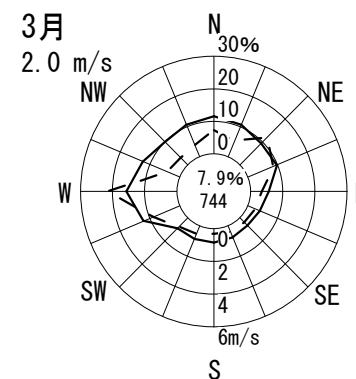
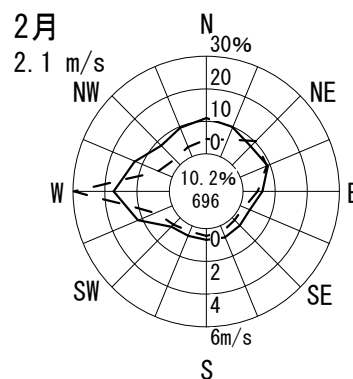
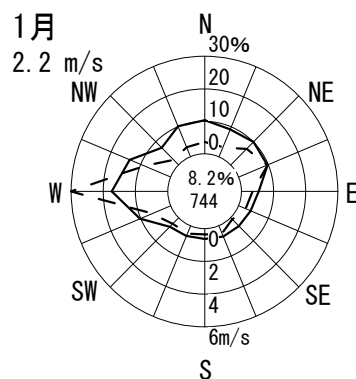
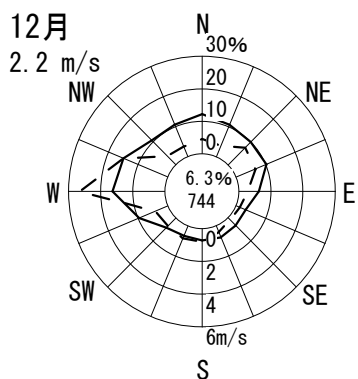
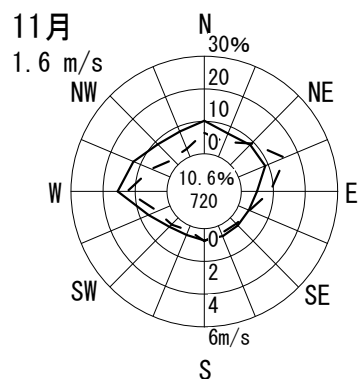
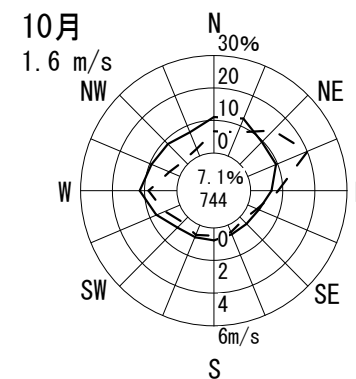
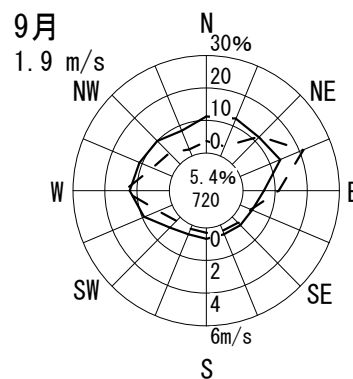
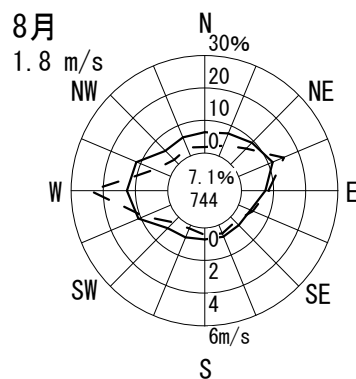
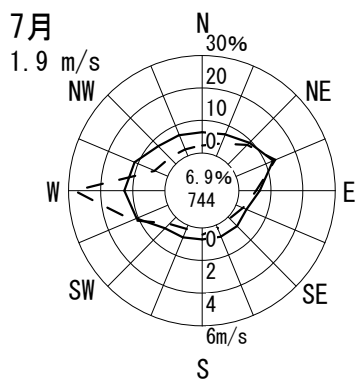
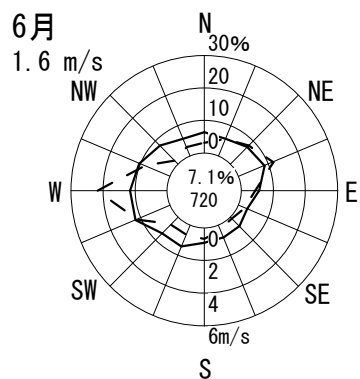
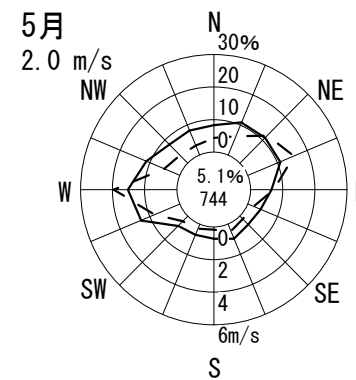
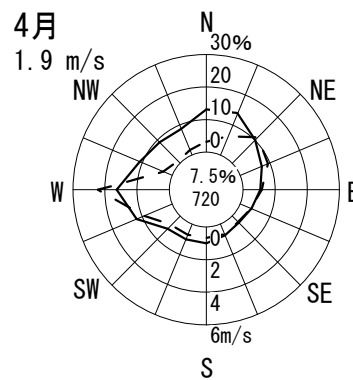
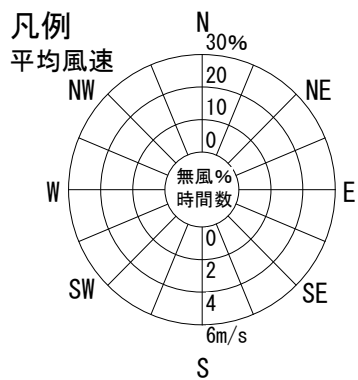
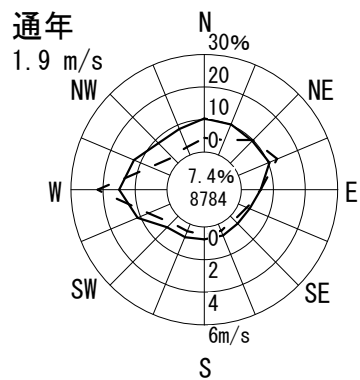

# 風配図 - 月別

測定局：美原丹上

2011年4月～2012年3月 1～24 時

風向風速計高さ 10.0 m

--- 出現頻度  
—— 平均風速

円内 無風%  
測定時間数

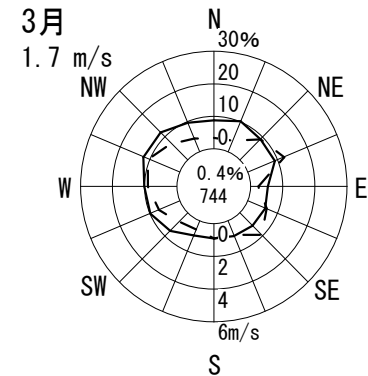
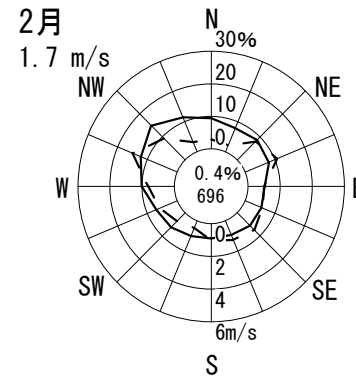
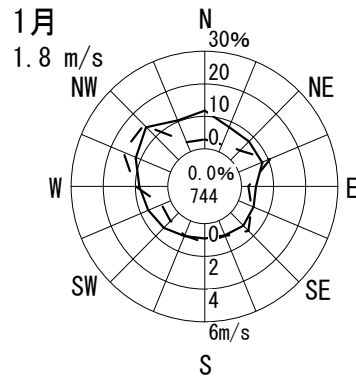
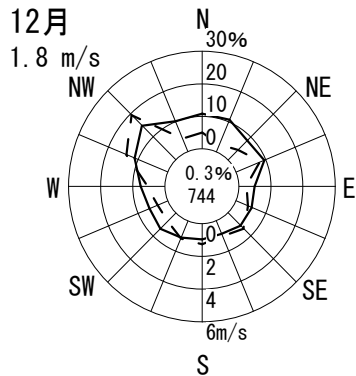
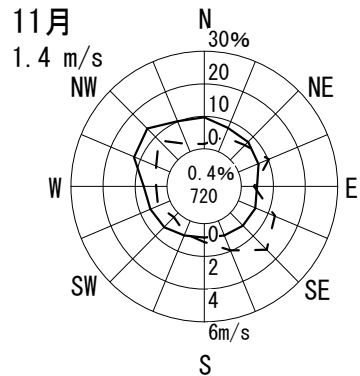
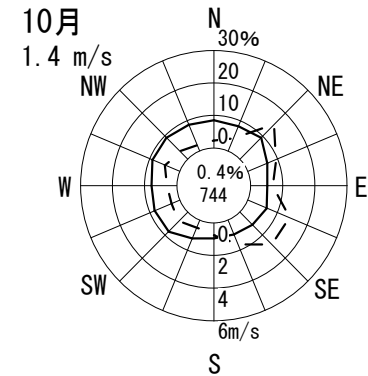
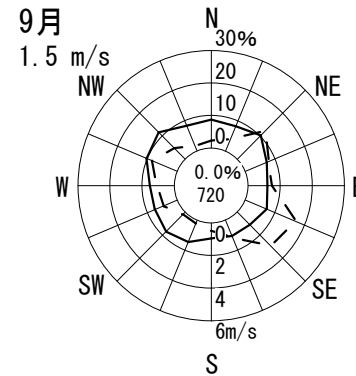
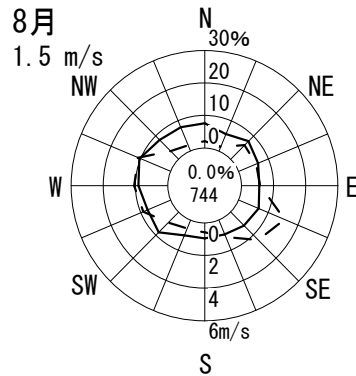
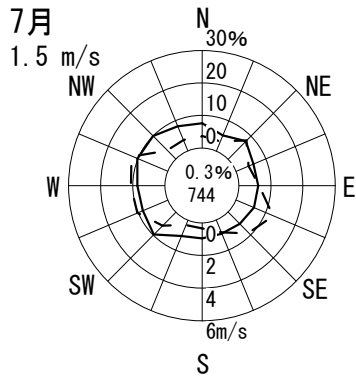
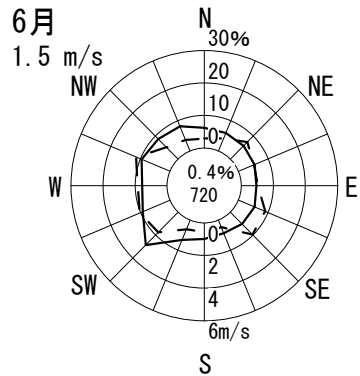
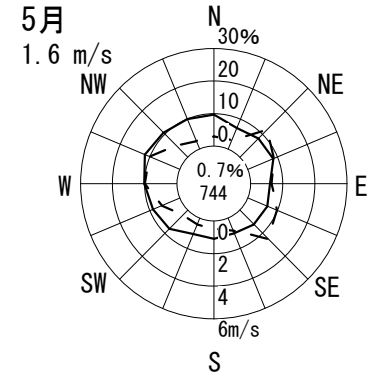
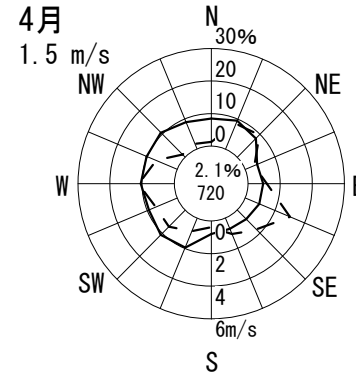
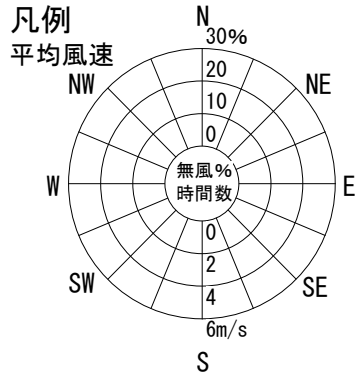
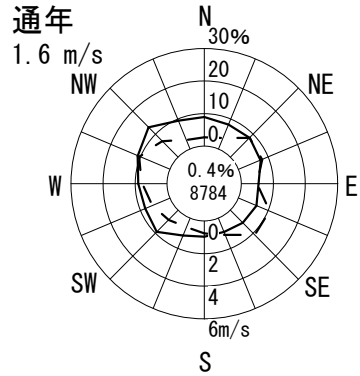

# 風配図 - 月別

測定局：豊中市役所

2011年4月～2012年3月 1～24 時

風向風速計高さ 38.0 m

--- 出現頻度

— 平均風速

円内 無風%  
測定時間数

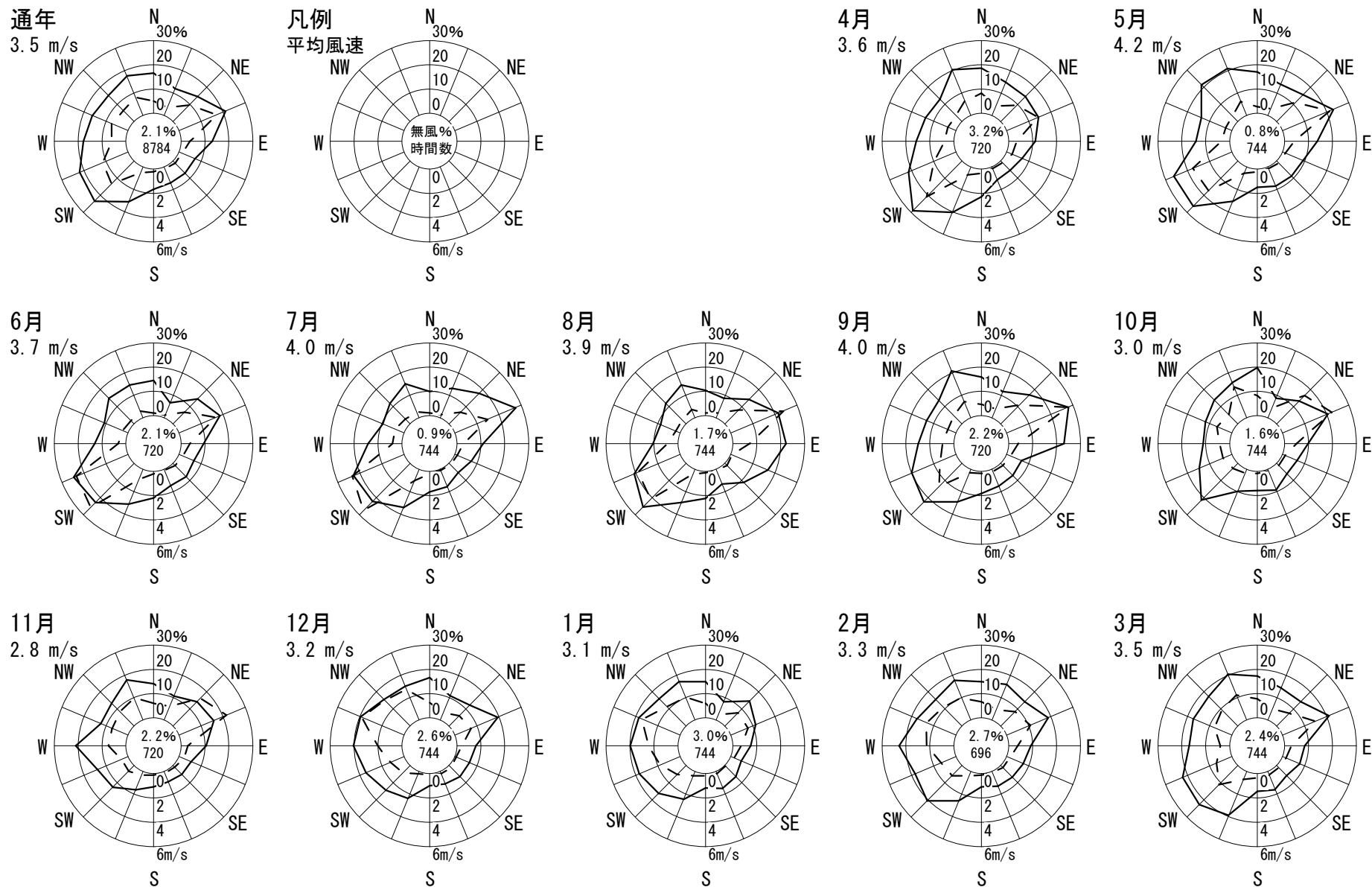

# 風配図 - 月別

測定局：千里

2011年4月～2012年3月 1～24 時

風向風速計高さ 11.0 m

--- 出現頻度

— 平均風速

円内 無風%  
測定時間数

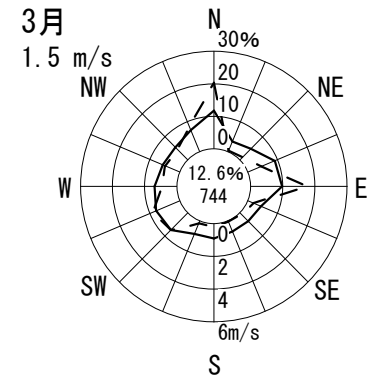
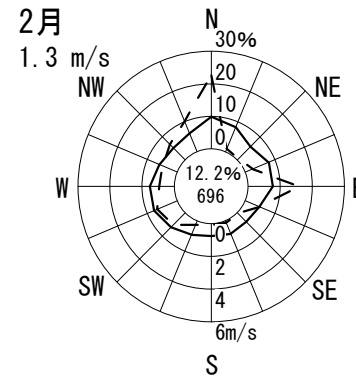
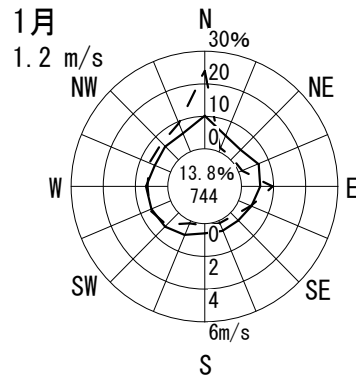
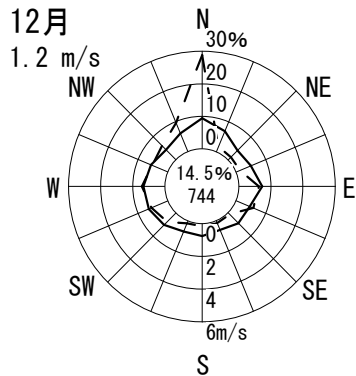
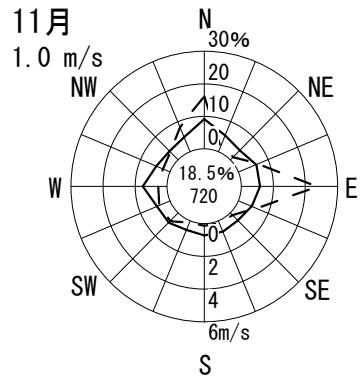
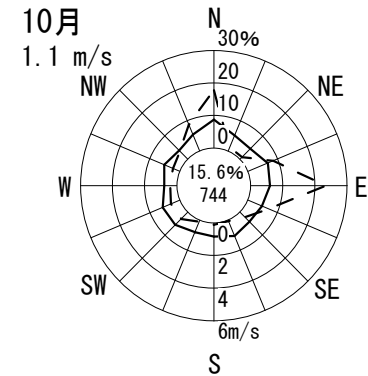
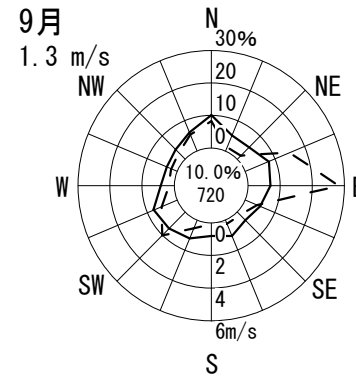
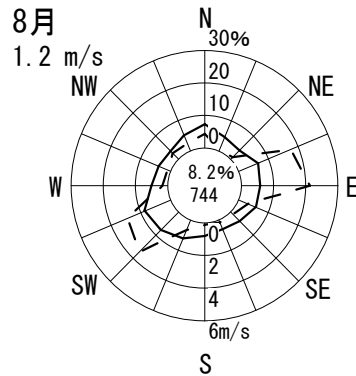
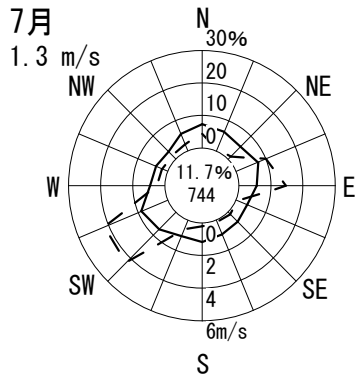
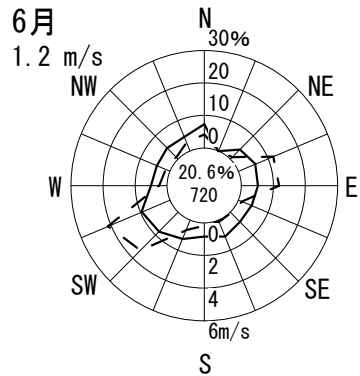
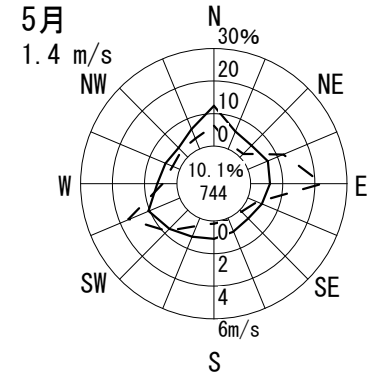
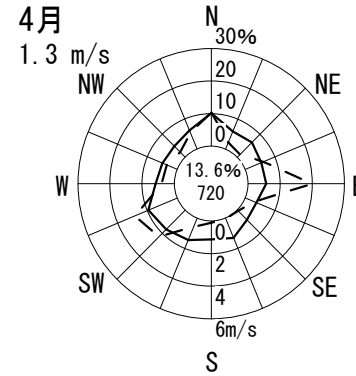
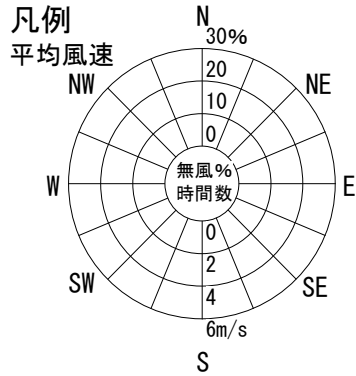
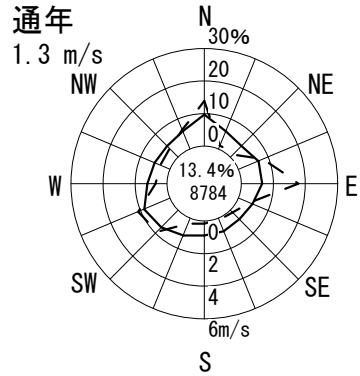

# 風配図 - 月別

測定局：吹田簡易裁判所

2011年4月～2012年3月 1～24 時

風向風速計高さ 8.2 m

--- 出現頻度

— 平均風速

○内 無風%  
測定時間数

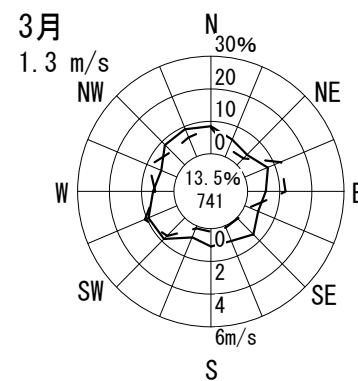
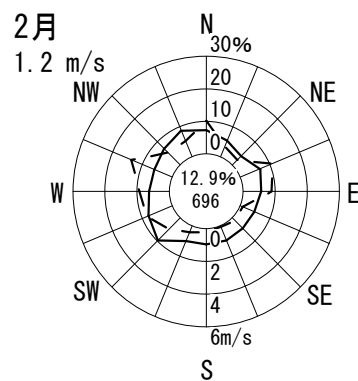
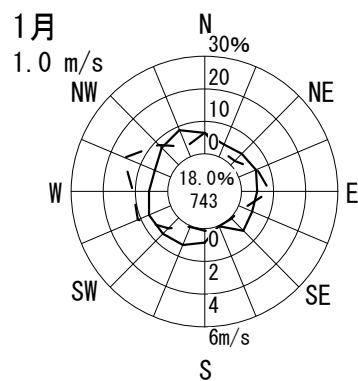
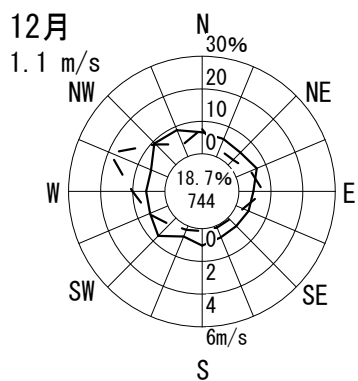
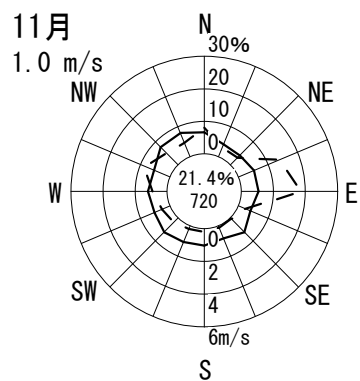
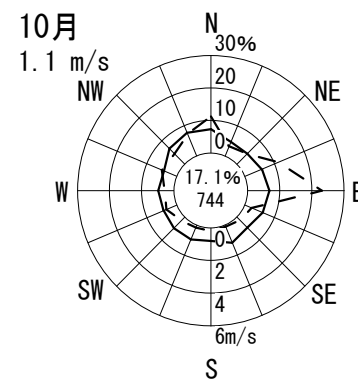
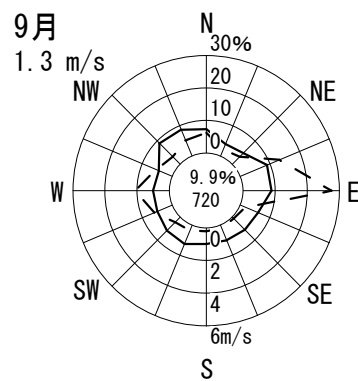
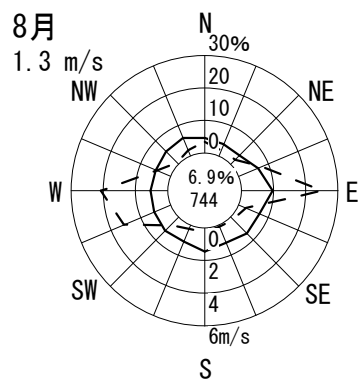
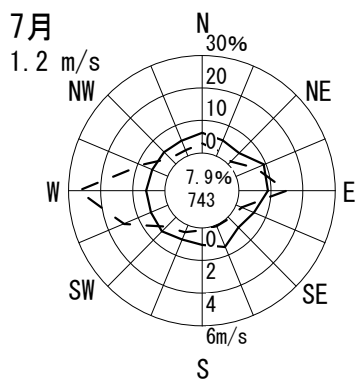
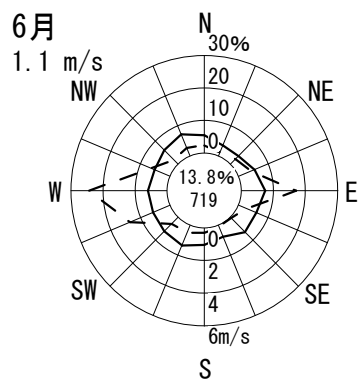
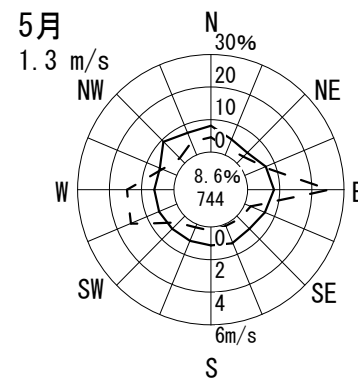
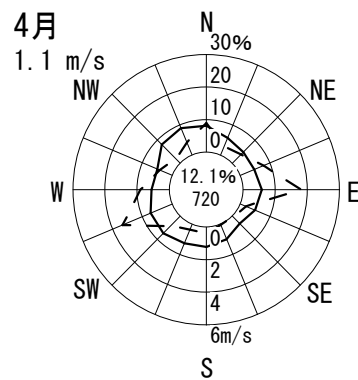
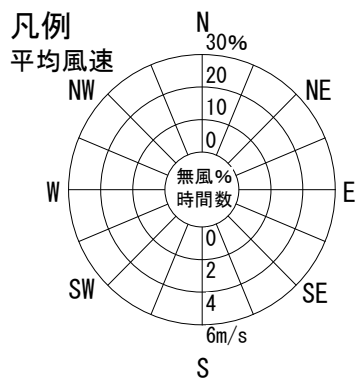
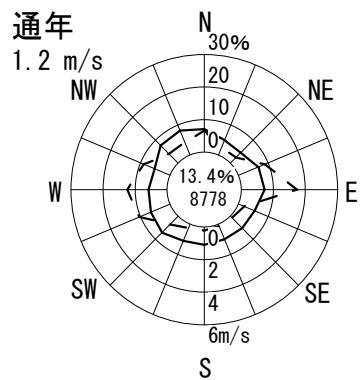

# 風配図 - 月別

測定局：高槻市役所

2011年4月～2012年3月 1～24 時

風向風速計高さ 11.2 m

--- 出現頻度  
—— 平均風速

円内 無風%  
測定時間数

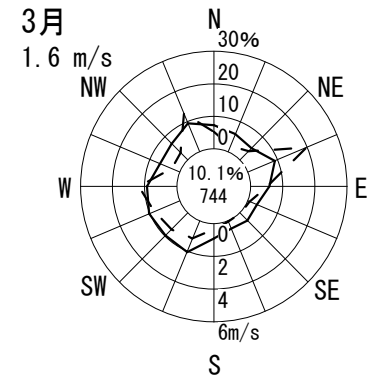
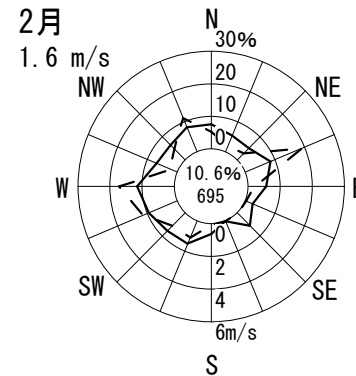
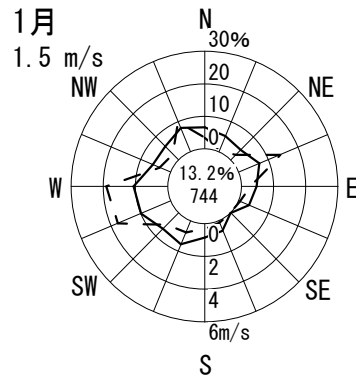
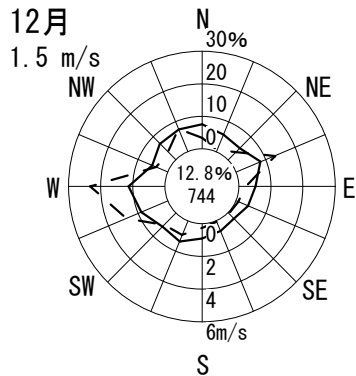
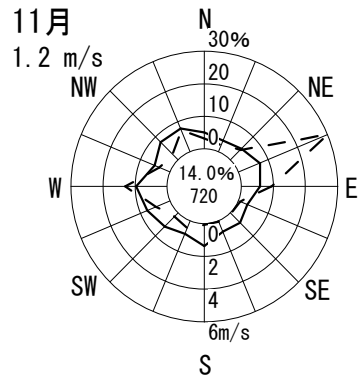
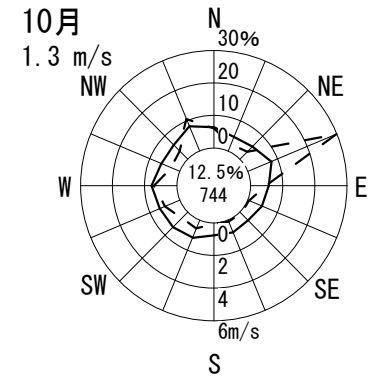
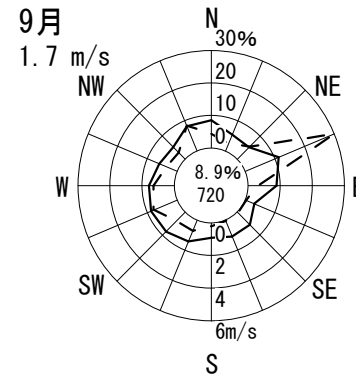
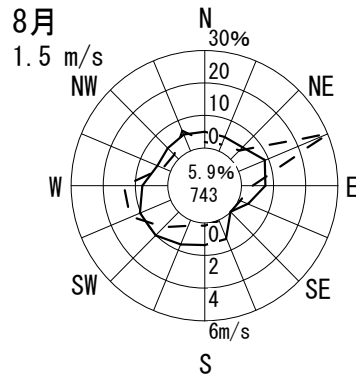
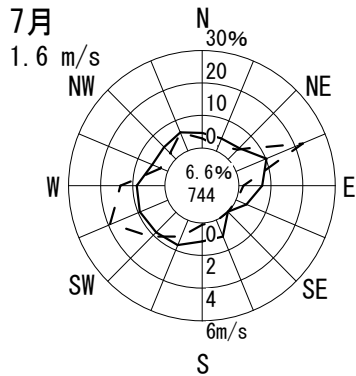
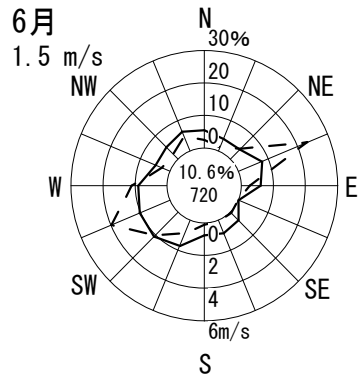
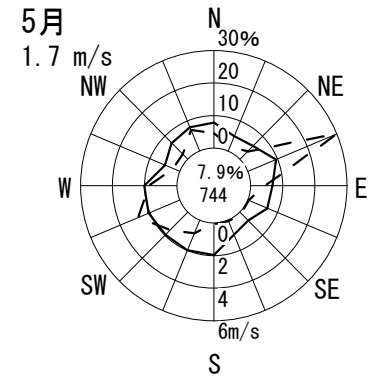
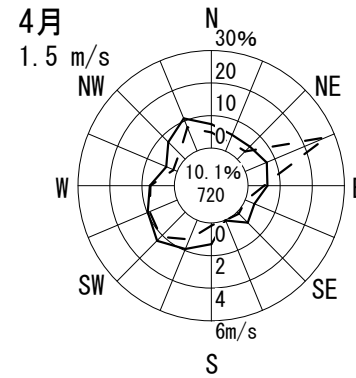
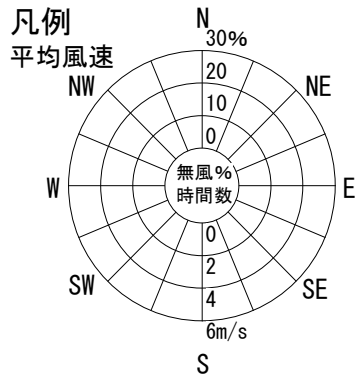
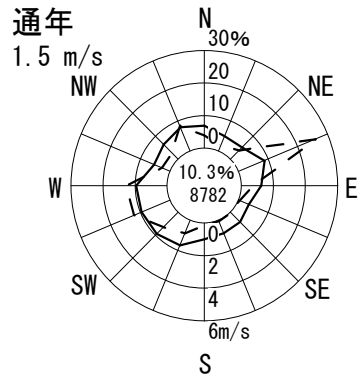

# 風配図 - 月別

測定局：緑が丘

2011年4月～2012年3月 1～24 時

風向風速計高さ 10.0 m

--- 出現頻度

— 平均風速

円内 無風%  
測定時間数

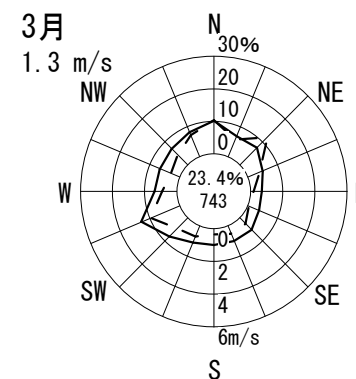
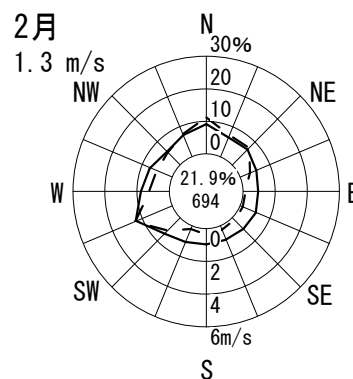
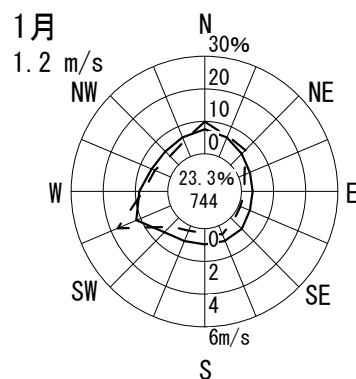
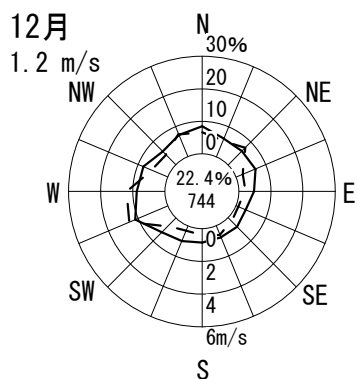
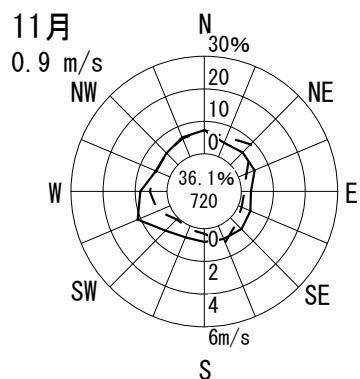
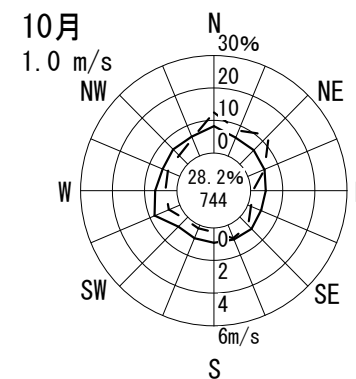
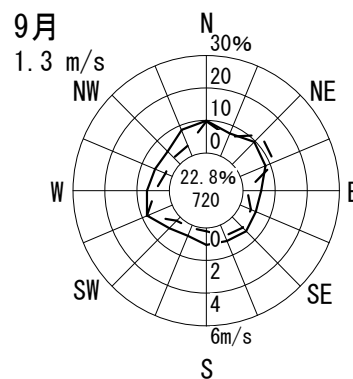
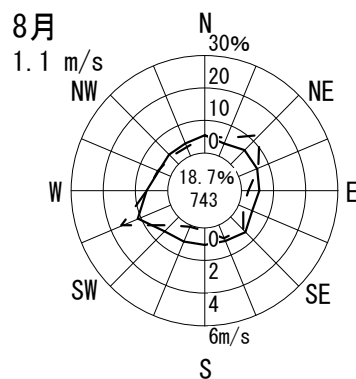
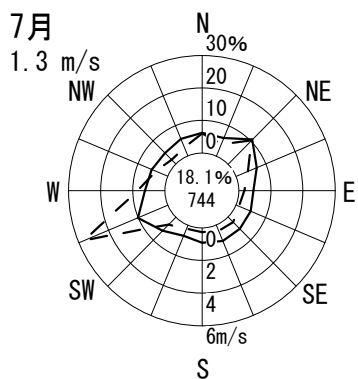
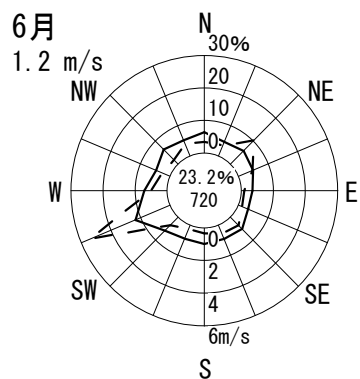
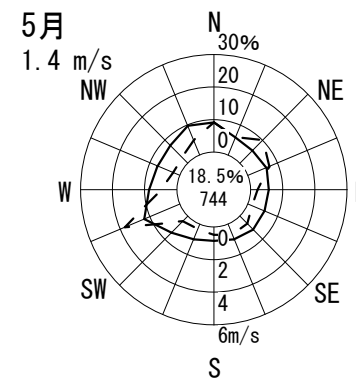
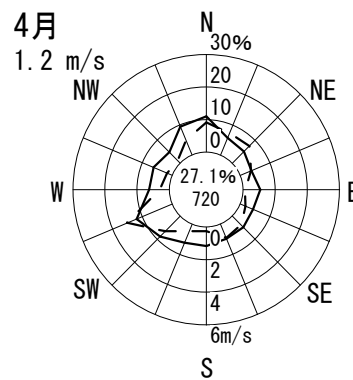
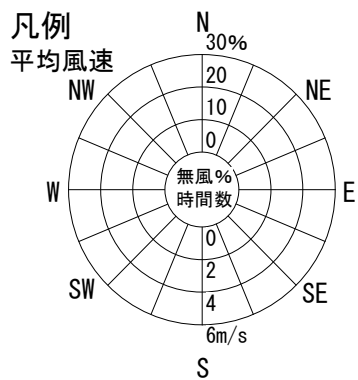
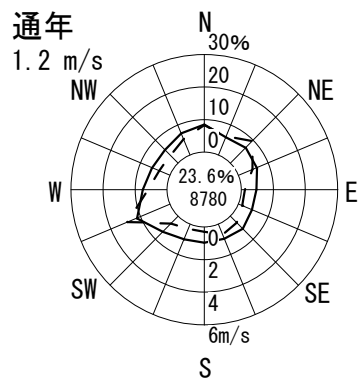

# 風配図 - 月別

測定局：招提

2011年4月～2012年3月 1～24 時

風向風速計高さ 7.0 m

--- 出現頻度

— 平均風速

円内 無風%  
測定時間数

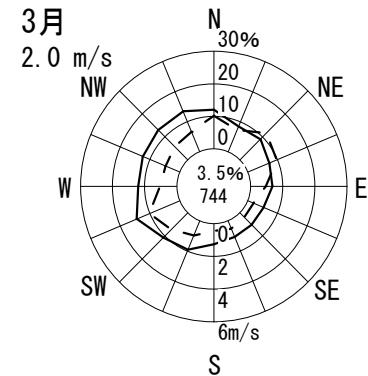
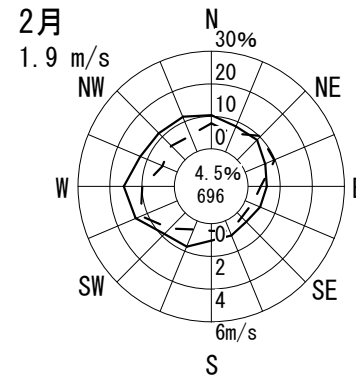
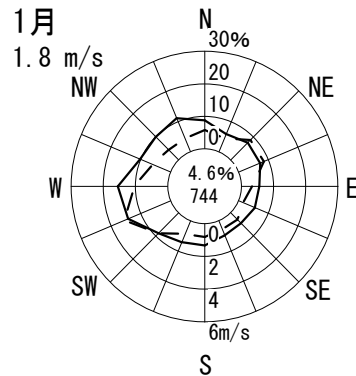
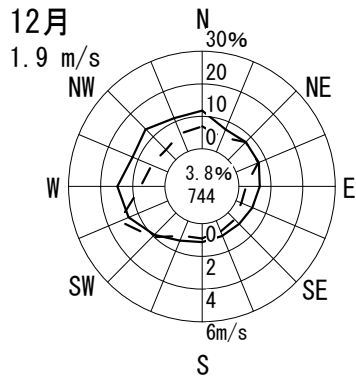
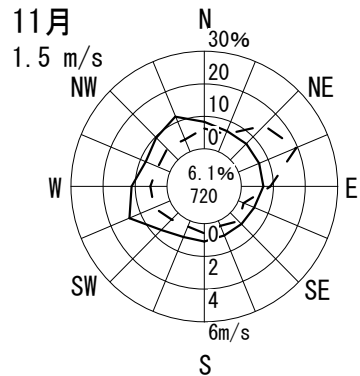
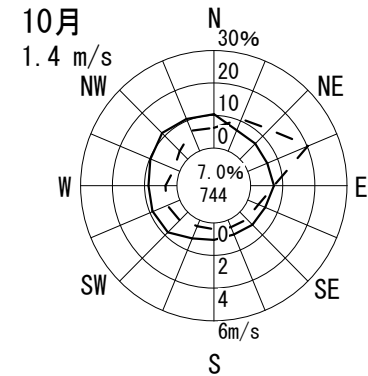
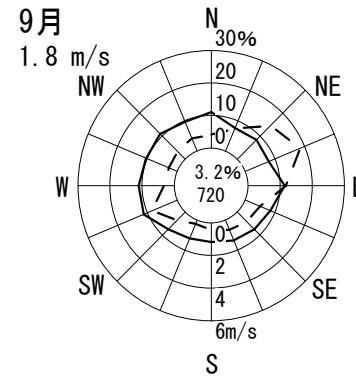
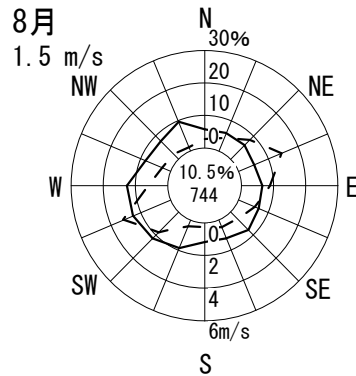
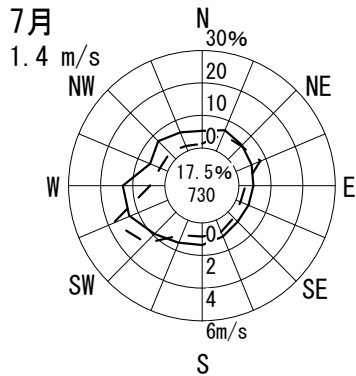
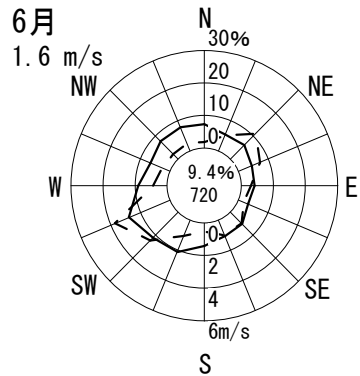
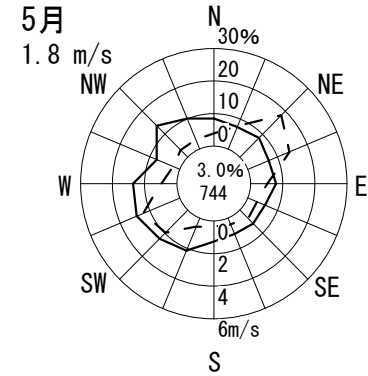
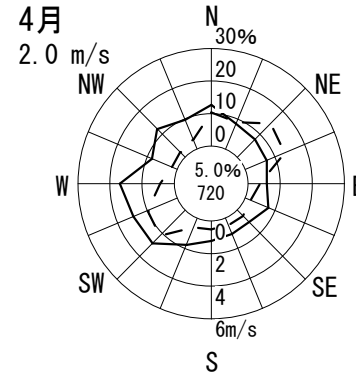
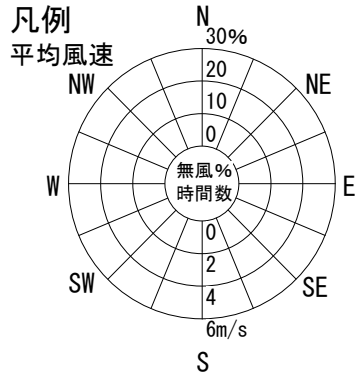
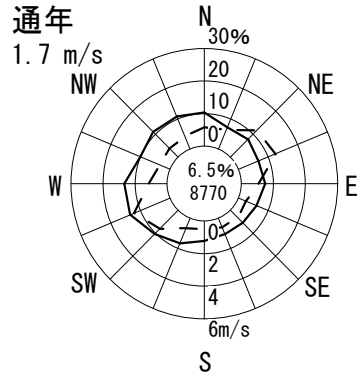



# 風配図 - 月別

測定局：中振

2011年4月～2012年3月 1～24 時  
風向風速計高さ 9.0 m

--- 出現頻度  
—— 平均風速

円内 無風%  
測定時間数

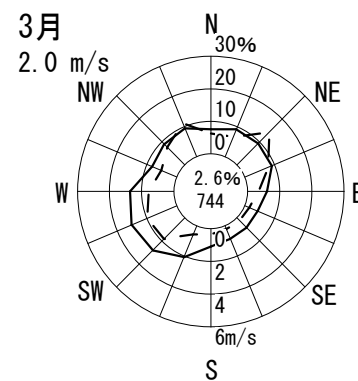
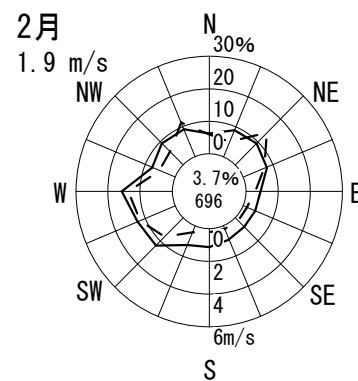
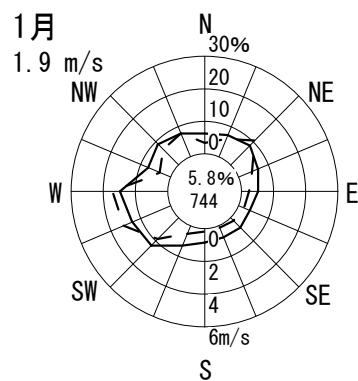
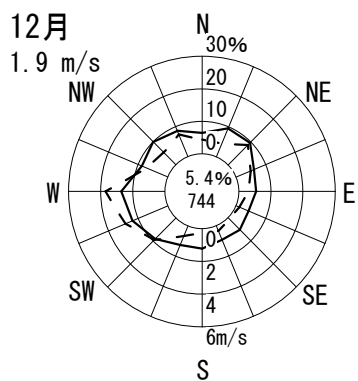
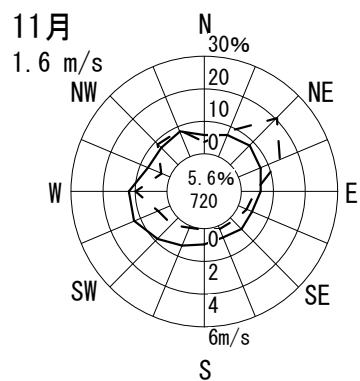
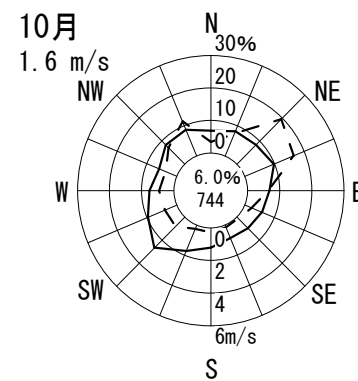
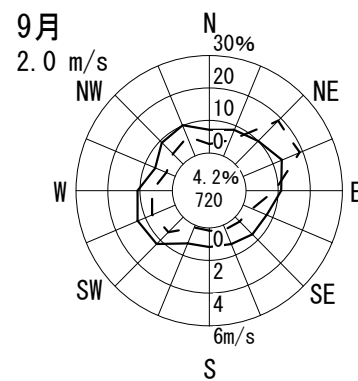
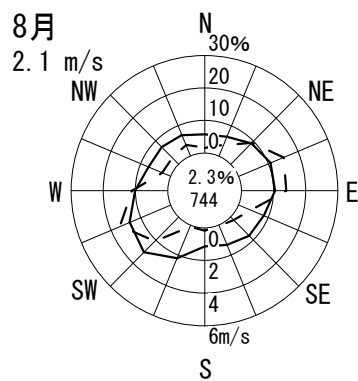
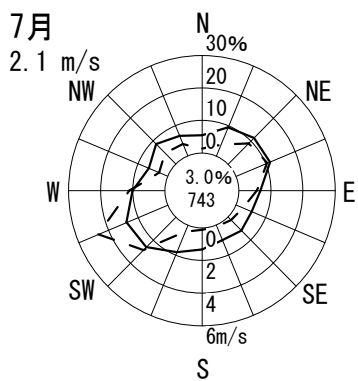
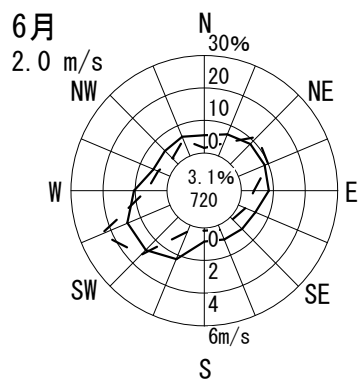
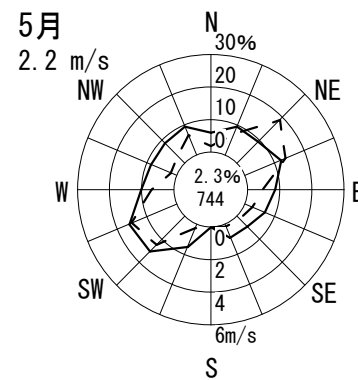
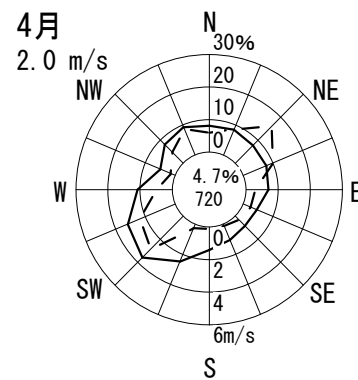
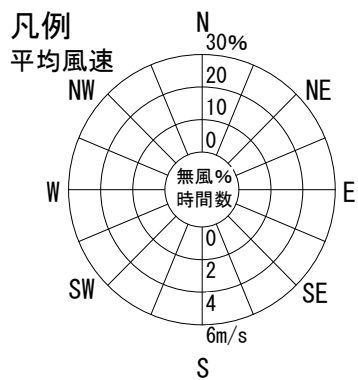
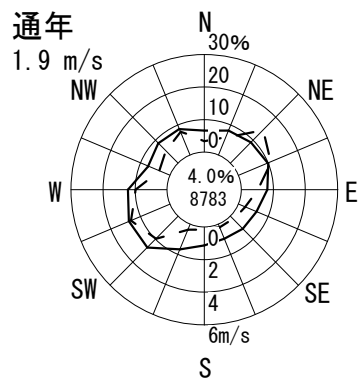

# 風配図 - 月別

測定局：末広公園

2011年4月～2012年3月 1～24 時

風向風速計高さ 14.6 m

--- 出現頻度  
—— 平均風速

円内 無風%  
測定時間数

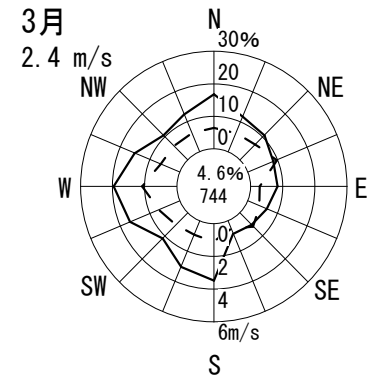
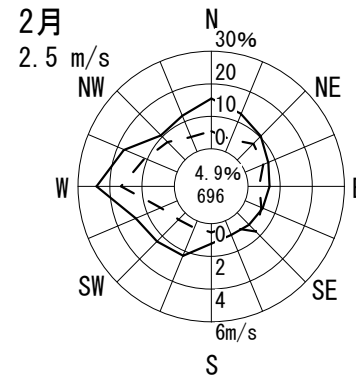
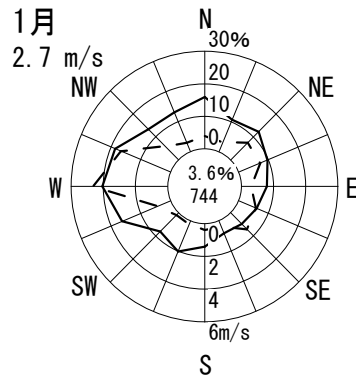
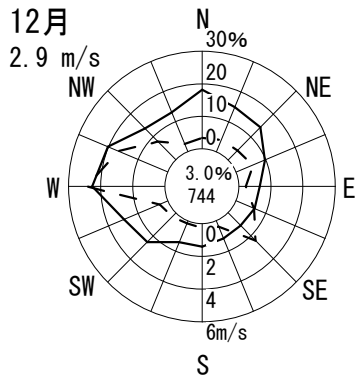
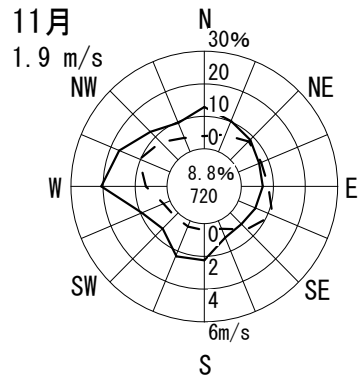
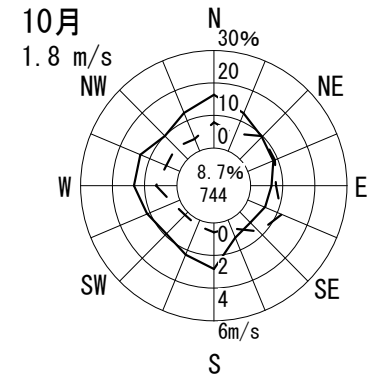
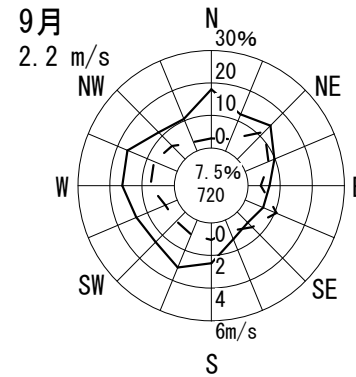
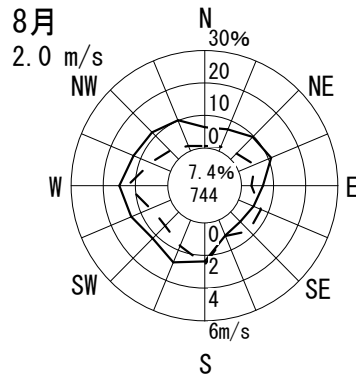
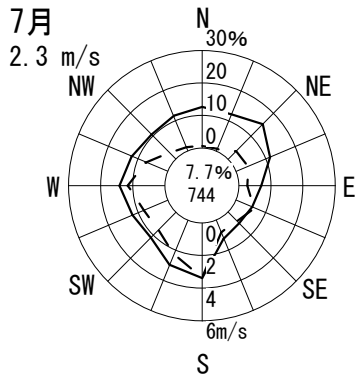
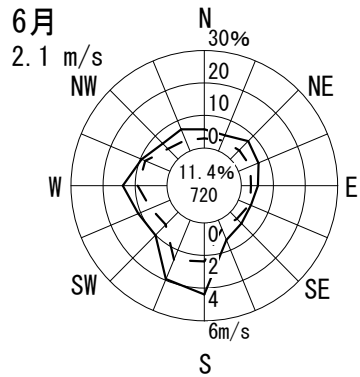
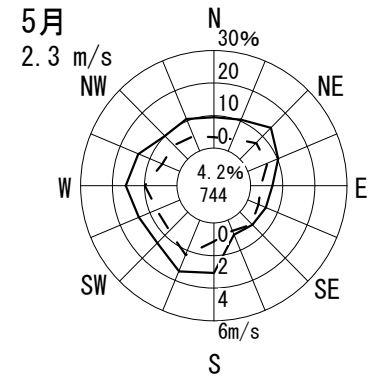
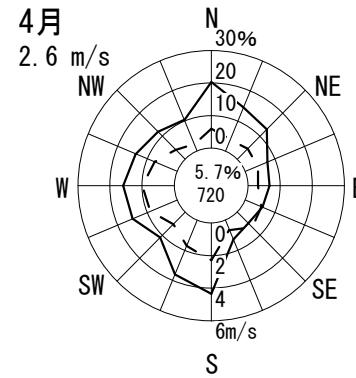
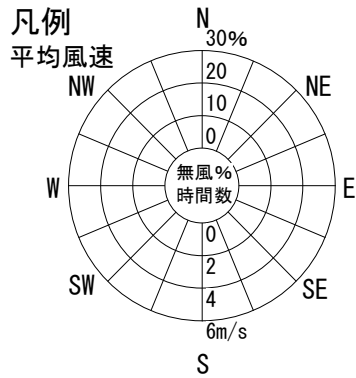
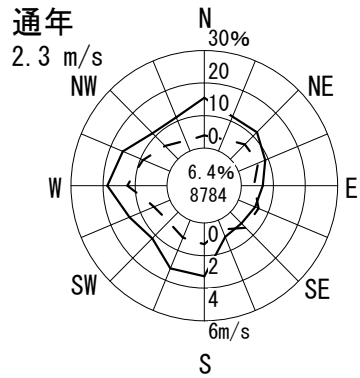

# 風配図 - 月別

測定局：東大阪市環境衛生検査センター

2011年4月～2012年3月 1～24 時

風向風速計高さ 15.0 m

--- 出現頻度

— 平均風速

円内 無風%  
測定時間数

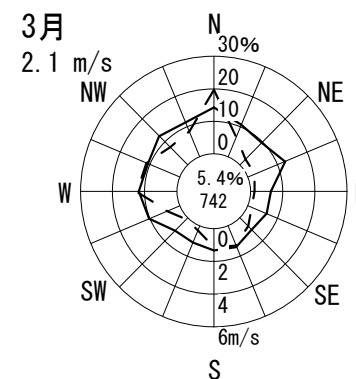
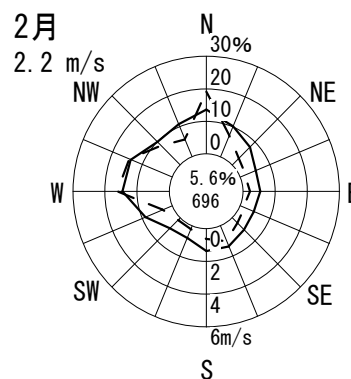
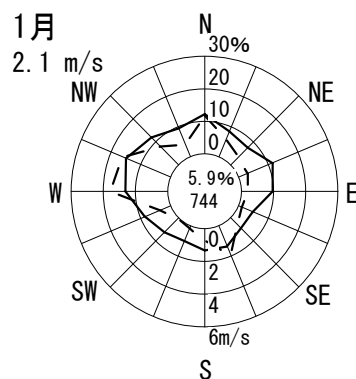
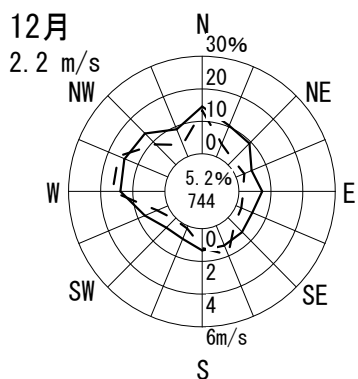
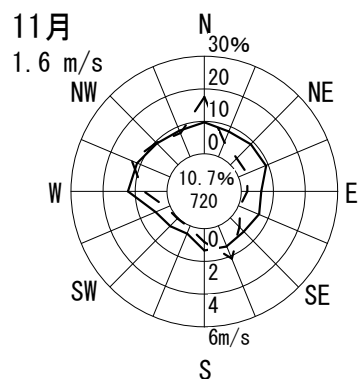
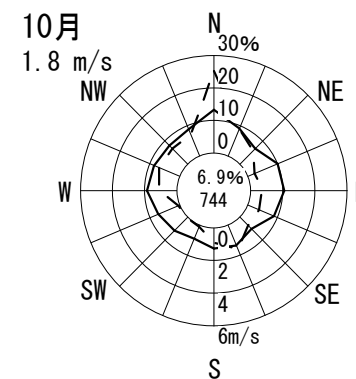
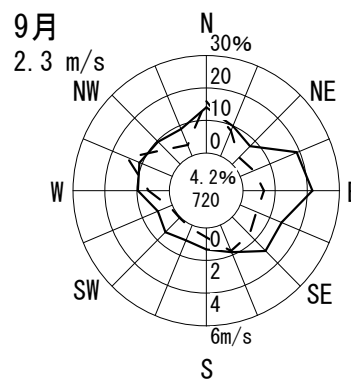
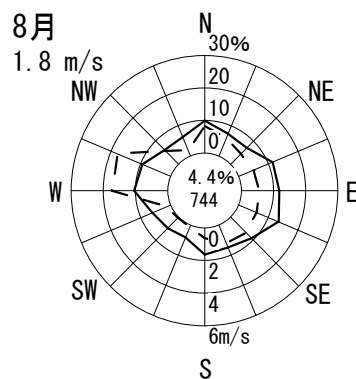
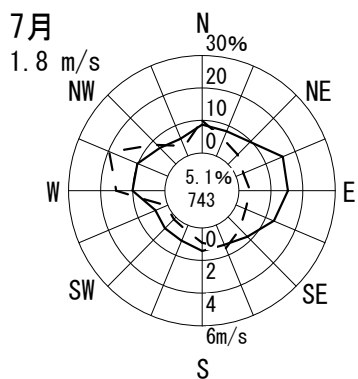
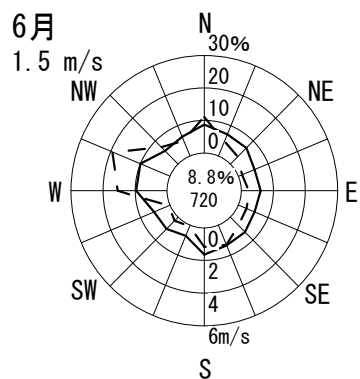
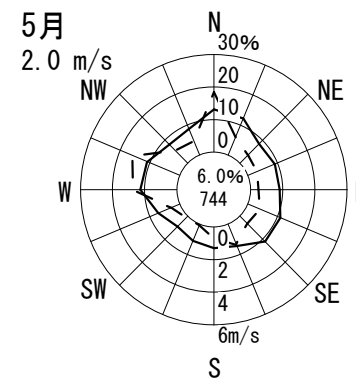
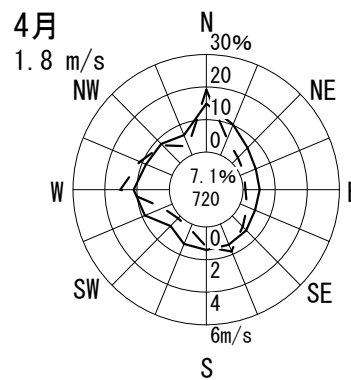
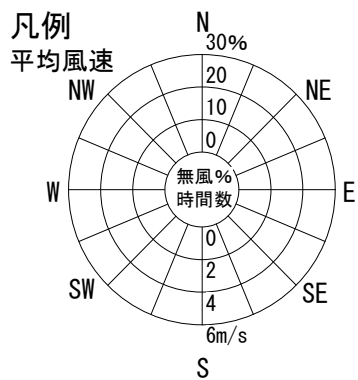
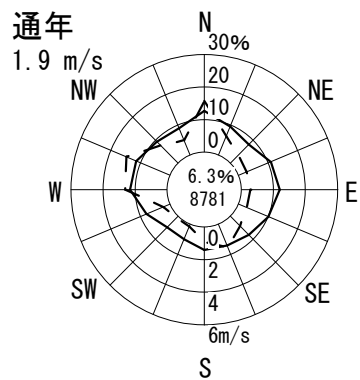

# 風配図 - 月別

測定局：国設四條畷

2011年4月～2012年3月 1～24 時

風向風速計高さ 10.5 m

--- 出現頻度

— 平均風速

円内 無風%  
測定時間数

